

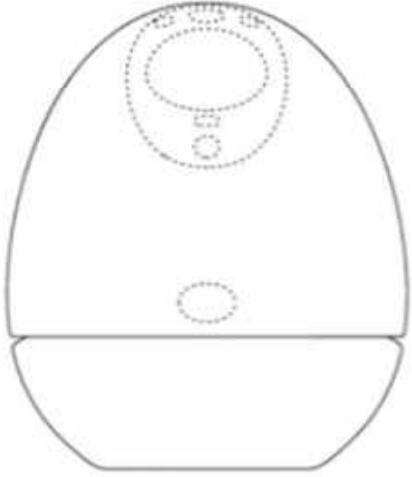

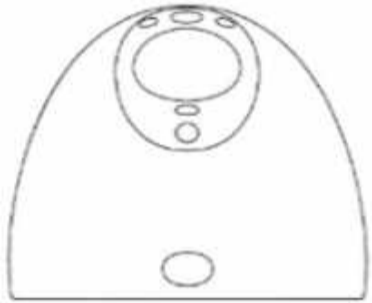













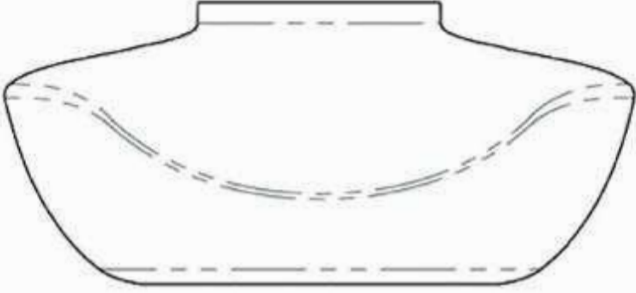

Annexe 1 - The registered design and comparable aspects of the MFM product

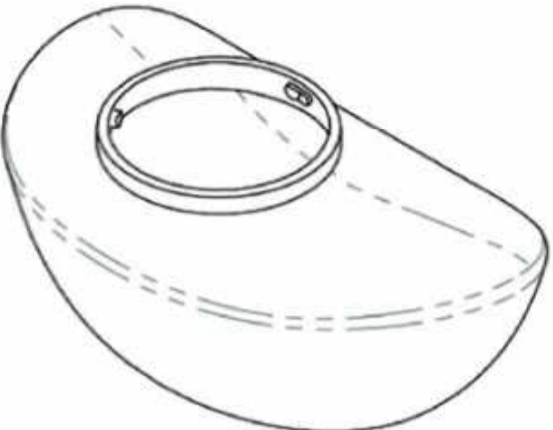
Registered Design	Defendant's product
0010 Design	
 A line drawing showing the front view of an egg-shaped object. It features a circular pattern of small dots at the top, a smaller circle below it, and a horizontal line near the bottom. The base is a flat, slightly wider section.	 A photograph of a white, egg-shaped object with a textured surface. It has a red circular feature near the bottom and a small logo with a star and the text "Summer Tippee" above it. The object is sitting on a clear glass base.
 A line drawing showing a three-quarter view of the egg-shaped object. It highlights the curved surface and the circular patterns of dots.	 A photograph of the white, egg-shaped object from a three-quarter perspective, showing its curved profile and the red circular feature.
 A line drawing showing the side profile of the egg-shaped object. It shows the curved top and the flat base.	 A photograph of the white, egg-shaped object from a side profile, showing its curved shape and the clear glass base.
 A line drawing showing the top view of the egg-shaped object. It features a central circular opening and a pattern of dots around the perimeter.	

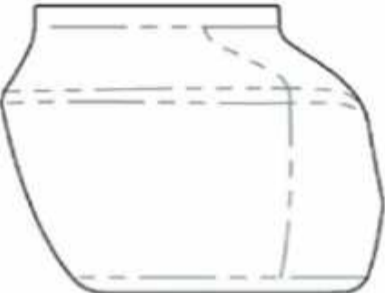

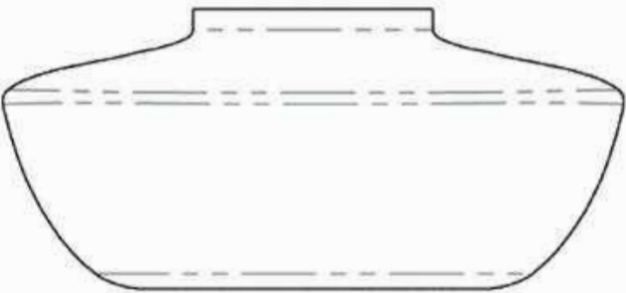
0002 Design	
Registered Design	MFM Product
	
	
	
	

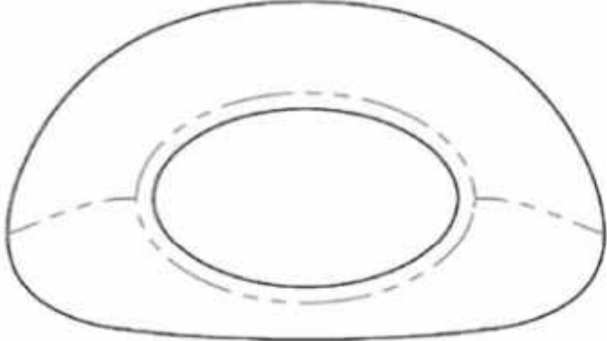
0003 Design	
Registered Design	MFM product

<p>(The back of the MCV – design 0003A)</p> 	<p>Rear face of the MFM product – photo A</p> 
	
	
<p>(The front of the MCV – design 0003B)</p> 	<p>Front of the MFM product – photo B</p> 
 <p>Bottom of the MCV</p>	 <p>Bottom of the MFM product</p>

NB – I have labelled the back and front of the registered design MCV because those are the appropriate faces to compare with the corresponding faces of the MFM product. As the defendant pointed out, but the claimant did not accept, the wrong faces are invited for comparison by the claimant.

Annexe 2 – types of breast pump on the market in 2018





Medela Symphony



Medela Freestyle Flex



Medela Freestyle wearable breast pump

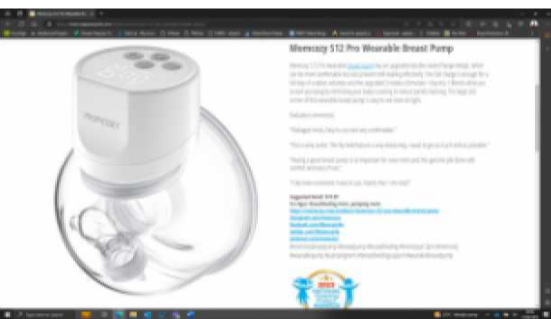

Momcozy S12



Willow (external view and the rear, opened up)

Annexe 3 – patents

The Whisper Wear patent (or Medela patent/application)

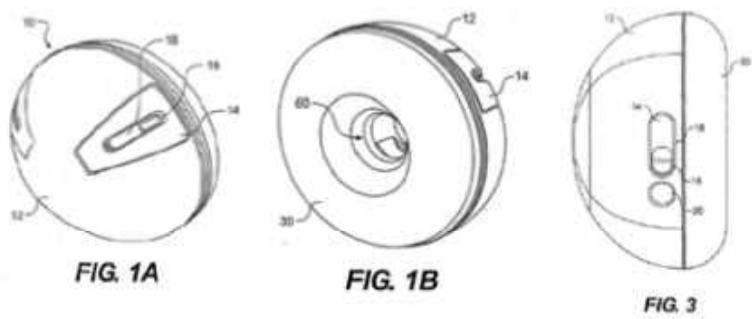

Dao patent

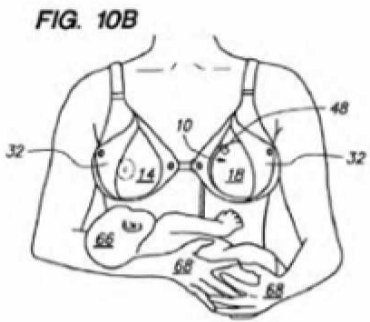
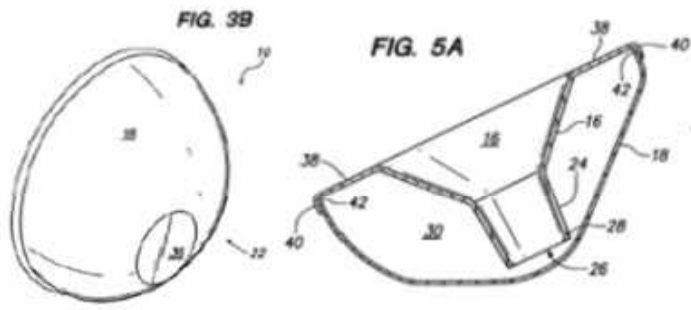

The Fischer patent

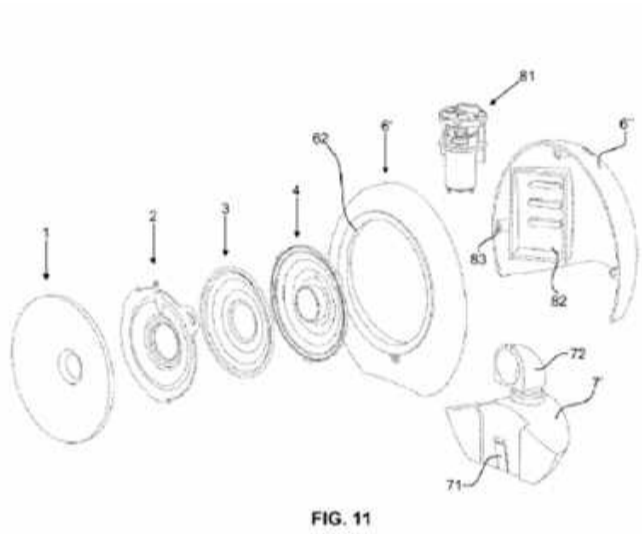

Annexe 4 – wearable pump design corpus (instances)

Medela Swing



Willow

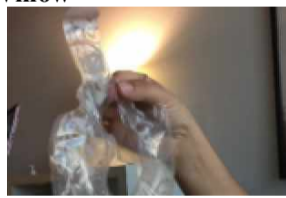

NB – milk collection vessel is a bag which sits round the pump.

Whisper Wear

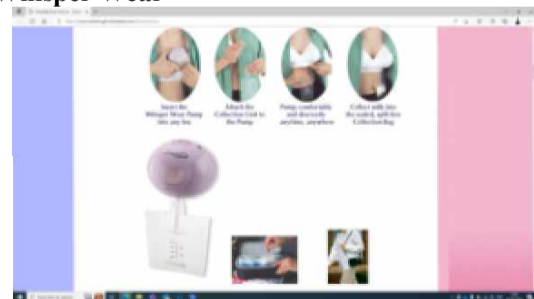

Freemie









Medela application (see Annexe 3)

Annexe 5 – designs since the date of the registered designs



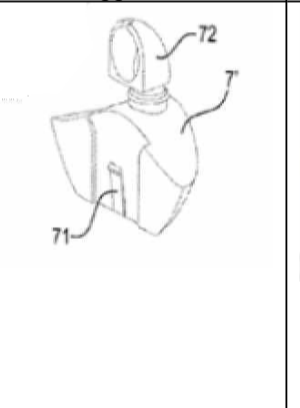

Differences in pump housings

ela Swing	Freemie	Willow	Momcozy
			

Differences in MCVs

ow	Whisper Wear	Medela Application	Willow Go
			

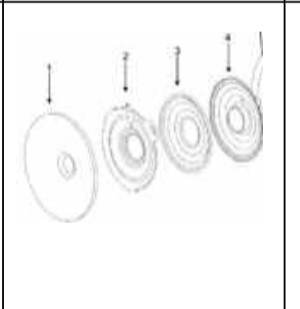
Differences in breast shield shapes

ela Swing	Willow	Medela Application	Willow Go
			

Annexe 6 – recent designs for in-bra wearables

ababy	Wearable Breast Pump	Mumgaroo	Chef Handy
			



cozy M1



Kisdream



Pippeta Compact

