



Neutral Citation Number: [2021] EWHC 1739 (Pat)

Case No. HP-2019-000006

IN THE HIGH COURT OF JUSTICE
BUSINESS AND PROPERTY COURTS OF ENGLAND AND WALES
INTELLECTUAL PROPERTY LIST (ChD)
PATENTS COURT

Rolls Building
Fetter Lane
London, EC4A 1NL
25 June 2021

Before :

MR JUSTICE MEADE

Between :

(1) OPTIS CELLULAR TECHNOLOGY LLC **Claimants**
(2) OPTIS WIRELESS TECHNOLOGY LLC
(3) UNWIRED PLANET INTERNATIONAL
LIMITED

- and -

(1) APPLE RETAIL UK LIMITED **Defendants**
(2) APPLE DISTRIBUTION
INTERNATIONAL LIMITED
(3) APPLE INC

Tom Moody-Stuart QC, Mark Chacksfield QC, Thomas Jones, Jennifer Dixon and Henry Edwards (instructed by EIP Europe LLP and Osborne Clarke LLP) for the Claimants
Michael Bloch QC, Guy Burkill QC, Lindsay Lane QC, Katherine Moggridge and Warren Fitt (instructed by WilmerHale LLP) for the Defendants

Hearing dates: 16, 19-23 and 26-28 April 2021

Approved Judgment

I direct that pursuant no official shorthand note shall be taken of this Judgment and that copies of this version as handed down may be treated as authentic.

Covid-19 Protocol: This Judgment was handed down remotely by circulation to the parties' representatives by email and release to Bailii. The date for hand-down is deemed to be 25 June 2021.

Mr Justice Meade:

Introduction	4
Conduct of the trial	4
Status of the previous decisions on the Patent	5
The patent issues.....	5
The witnesses	6
Technical experts.....	6
ETSI experts.....	8
The skilled addressee	10
The common general knowledge.....	10
Agreed common general knowledge	10
Disputed and potentially disputed common general knowledge.....	19
What was and was not disputed	19
Poll prohibit timers and status prohibit timers	20
Scheduling algorithms, round trip times, no further PDUs	20
The Patent.....	21
Claims in issue	23
Proposed amended claims:.....	24
Claim interpretation	24
“Counting”	24
Claims 6 and 9 – “resetting”	26
Claims 6 and 9 – timing.....	26
Claim 9 – “or”	27
Validity.....	29
Anticipation – the law.....	29
Pani/P3	31
Assessment.....	37
Allowability of the amendments	39
InterDigital	39
InterDigital - Anticipation by equivalence	48
Obviousness over InterDigital.....	50
Legal principles	50
Pozzoli questions 1 and 2.....	51
Pozzoli question 3.....	51
Pozzoli question 4.....	52
Claim 9.....	54
The estoppel issues	55
Outline	55
“Patent ambush”	58
Case management.....	58
The law of proprietary estoppel.....	59
Basic elements of the doctrine	59
The three elements.....	59
The role of unconscionability, not a “joker”	61
No watertight compartments	62
No categorisation.....	63
Inaction or silence.....	63
Detriment	65

Reliance and causation	67
French law	67
Basic provisions	69
Clear and Precise	70
The materials available for the exercise of interpretation.....	71
Collective contracts and standard form contracts	72
Usages	72
Means v. Result	72
Presumptions	73
Interplay of the above principles.....	73
Facts relevant to the estoppel allegations.....	74
ETSI.....	74
3GPP	75
Working groups, meetings, submissions	78
Declaration timing	79
Awareness of declaration timing.....	80
How declarations were made	80
Assessment of essentiality	81
Whether WG participants checked the IP status of TDocs.....	81
What RAN WG2 participants would have thought about the Ericsson TDoc..	83
Available alternatives	84
ETSI IPR Policy over time	85
The 1994 Interim IPR Policy	87
3GPP Partnership Agreement	91
2003 AHG Review	91
The 2004 IPR Guide.....	95
DG Comp’s proposed changes.....	101
Conduct and states of mind of Ericsson and of Apple	103
Meaning of Clause 4.1 – Assessment	104
Unpublished patent applications	107
Conclusion on Clause 4.1	107
Analysis of Apple’s primary “No-IPR” case	107
Assurance	107
Reliance and detriment	108
Unconscionability.....	109
Analysis of Apple’s secondary case	109
Remedy	109
Transfer of the benefit and of the burden.....	109
“Transfer” of the benefit.....	110
Transfer of the burden	111
Bona fide purchaser for value without notice	111
Conclusions	112

INTRODUCTION

1. This trial concerns European Patent (UK) No. 2 229 744 B1 (“**the Patent**”). It is one in a series of trials in this multi-patent action. It is referred to as “Trial B”. In Trial A, Birss J (as he then was) found another patent, which has now expired, valid and infringed. Further trials are scheduled, including on FRAND issues.
2. The Patent has been litigated before, in proceedings between Unwired Planet and Huawei. There was a trial, also before Birss J: [2015] EWHC 3366 (Pat), to which I will refer below. He found the Patent valid and essential/infringed. His decision was upheld by the Court of Appeal at [2017] EWCA Civ 226.
3. As pleaded, this trial was to concern:
 - i) Whether the Patent is valid, with validity challenged on numerous grounds;
 - ii) Whether the Patent is essential/infringed;
 - iii) Whether, if the Patent is valid and infringed, Apple has a defence of proprietary estoppel arising from the way in which the former owner of the Patent, Ericsson, behaved in relation to the adoption of the solution of the Patent into the LTE standard.
4. These issues narrowed, as I will explain below.

CONDUCT OF THE TRIAL

5. The trial was conducted in Court. All the oral evidence was given live. To mitigate the COVID risk, the number of representatives of the parties and their clients permitted at any one time was limited, and a live feed was made available for others, and for the public if they asked. I am grateful to the third-party providers engaged by the parties to make the technology work.
6. The parties each had effectively two separate teams of lawyers, one team for the validity/essentiality issues and one for the proprietary estoppel issues. Only one team on each side was in Court at once.
7. In terms of Counsel:
 - i) For Optis, Mr Moody Stuart QC, Mr Jones and Ms Dixon handled the patent issues while Mr Chacksfield QC and Mr Edwards dealt with estoppel.
 - ii) For Apple, Mr Burkill QC, Ms Lane QC and Ms Moggridge were the patent team, with Mr Bloch QC and Mr Fitt on estoppel.
8. Where I refer to Counsel for Optis or Counsel for Apple it will be apparent from the context whom I mean.
9. There was one issue on which the patent issues and proprietary estoppel issues representation/witnesses crossed over, and that was in relation to whether there were non-patented technical alternatives to the invention of the Patent. The patent

advocates dealt with the evidence and the results were carried into the estoppel submissions.

STATUS OF THE PREVIOUS DECISIONS ON THE PATENT

10. Apple submits that there is no overlap between the *Unwired v. Huawei* action and this one, even though they concern the same patent. Apple submits that the prior art is new and different, giving rise to a new construction point (“counting”); that the expert evidence is different and from different witnesses; and that the estoppel arguments are new. Apple is right about all this and I accept its submission that this trial starts with a “clean sheet of paper”.
11. Optis did not in general contest this too much. It did try to argue that a point of claim construction decided by Birss J, on claim 9, could be relied on. While recognising that points of claim construction depend on evidence, such as to common general knowledge (“CGK”) (see *Novartis v. Dexcel* [2008] EWHC 1266 (Pat)), Counsel for Optis argued that there was no conceivable difference in the evidential setting to this action compared with the earlier one, so that I should follow what Birss J decided.
12. Working out if the evidential setting is different would be burdensome and anyway is unnecessary, because although what Birss J said in the previous judgment at [95] (“There is no doubt claim 9 refers to resetting both counters when either has reached the trigger.”) superficially contains the proposition Optis now argues for, he was not considering the point now in issue (whether there is a dual reset when *either* trigger is met). Rather, he was considering whether the claim covered a situation where there was a dual reset when either trigger was met *and* in other circumstances. Counsel for Optis accepted this. Even if the evidence of the CGK and so forth is no different now, I cannot get anything from a summary sentence included in Birss J’s decision on a different point.
13. I have inevitably had to look at Birss J’s judgment to understand and assess this point. Since my conclusion is that I must approach the matter entirely afresh, I have avoided studying his judgment at all closely, lest what happened should influence me subconsciously. I think it only fair to say that the limited reading I did left me with the impression that the arguments and approaches of the parties were very different then from now. That Apple’s attacks are different from those of Huawei, to the extent they are, has no relevance to whether they are right or wrong.

THE PATENT ISSUES

14. The issues narrowed in the run up to trial, and during trial. The remaining issues are:
 - i) The nature of the skilled team, where there was minimal disagreement.
 - ii) The scope of the common general knowledge. There were only minor issues over this.

- iii) Claim construction. There were multiple issues and they are critical to (in particular) the anticipation arguments.
 - iv) Anticipation over a patent application referred to as “**Pani**” (PCT Application WO 2008/097544). Pani was prior art for novelty only. Novelty has to be assessed for the granted claims and, if those are anticipated, in respect of conditionally amended claims.
 - v) Anticipation and obviousness over prior art referred to as “**InterDigital**” (TDoc R2-071618). In relation to anticipation, I allowed an application at the start of trial by Apple to plead anticipation by equivalence as well as on the ordinary, purposive meaning of the claims.
 - vi) Whether the proposed amended claims are allowable or whether they lack clarity or add matter.
15. A number of issues were dropped by Apple just before trial. In particular, it conceded essentiality/infringement and dropped the Motorola prior art (R2-073538, which was unsuccessfully run by Huawei). It was welcome that these points were dropped. It was unfortunate that they were dropped so very close to trial that Optis’ skeleton was already complete and there was not enough time for it to remove the sections affected, but only to colour them to show the broad areas of impact. I was assured by Counsel for Apple, and accept, that this was not tactically motivated. It often happens in patent cases that the interplay of issues is fully appreciated only in the run-up to trial with the reply evidence in hand, and in international litigation the effect of concessions in other jurisdictions has to be weighed up, and client sign-off obtained. Nonetheless, it helps the other side and the Court if concessions can be made in time for the other side’s skeleton to be addressed to the live issues only, without the inclusion of extraneous material. I think with a little more thought, Apple could have achieved this.

THE WITNESSES

16. Each side called two experts.

Technical experts

17. Optis’ technical was Mr Keiichi Kubota. He worked for Nokia from 1999 to 2006 and again from 2008 to 2010, in Japan and in the UK. He worked for NEC from 2006 until to 2008. In 2010 the part of Nokia for which he worked was acquired by Renesas and then later by Broadcom. From 2014 he worked for Qualcomm, and from 2018 until he became a consultant in August 2020, he worked for Rakuten. His work has covered UMTS, LTE and 5G and has covered RRC, RLC and MAC protocols. He has been involved extensively in 3GPP standardisation work, including attending Working Group meetings.
18. Apple’s technical expert was Mr Mathieu Boué-Lahorgue. He worked for Nortel from 2001 to 2009 and then at SFR from 2009 to 2017 when he became a consultant. While at Nortel he worked on UMTS and LTE standardisation and

was the company's lead delegate at RAN WG2 meetings, with responsibility covering RLC, MAC and RRC.

19. Optis made no criticism of Mr Boué-Lahorgue and he was a very good witness.
20. Apple submitted that Mr Boué-Lahorgue had experience of actually attending standardisation meetings on the relevant areas of technology around the priority date, while Mr Kubota only provided "remote support" at Nokia, which means he reviewed proposals and wrote analyses. This was a trivial difference (not least because Mr Kubota did attend standardisation meetings, albeit a bit later in time) and in any event just an exercise in comparing which expert was in point of historical fact closest to the notional skilled addressee. Such comparisons have been held irrelevant in numerous decisions. In terms of qualification and expertise, both experts were very well qualified.
21. Apple made a number of criticisms of Mr Kubota apart from his expertise:
 - i) That he gave evidence as an advocate not an expert. Insofar as this was a comment based on his demeanour, I reject it. Certain examples were given which I will now move on to.
 - ii) That in connection with InterDigital he said it was complex in relation to anticipation and simple when it came to obviousness. This was a bad point, since what he said was that windows-based approaches have more complexity than counter-based ones, which is true, and that InterDigital itself claims to be simple, which is also true. It was also a very small point even if correct, not justifying a personal criticism.
 - iii) That he avoided using the word "count" and instead used verbs like "observing". Since a crucial issue in the case is what "counting" means, it was wise to avoid its use in disputed or potentially ambiguous contexts.
 - iv) That he read Pani too literally and not with adequate regard to the CGK. Since Pani was a novelty-only citation it was necessary to avoid obviousness-type considerations in assessing it. If Mr Kubota was a bit too literal, which he perhaps was (on whether the counter was taught as incrementing, a minor issue), it was not because he was being an advocate.
 - v) That the length of time he spent over answers on P3 supported the inference that he had not read it before, even though he said he had. The inference was not remotely justified. He obviously knew it quite well and was taking his time. I was surprised to see this point maintained in Apple's written closing.
 - vi) That his collation of TDocs in exhibits KK2 and KK3 and his evidence based on them were not fairly put together because where companies initially expressed one opinion consistent with his thesis, but changed their opinion and ended up taking positions that were inconsistent, he mentioned their initial opinion. I agree that this was a slightly odd way to present things, but accept his explanation that he was working through things chronologically. His written evidence acknowledged the changes of view

explicitly not long after stating the initial opinions, so he did not conceal anything.

22. Overall, there is nothing in any of the points save the last, and precious little in that. I reject the attack on Mr Kubota.
23. I feel I should mention that Mr Kubota gave evidence in English without an interpreter. His mother tongue is Japanese. His comprehension of English struck me as perfect, but he retains quite a strong Japanese accent and occasionally his syntax and grammar when speaking in English are imperfect. I am confident that I understood clearly what he was saying during his oral evidence, but in re-reading the transcript for the purpose of preparing this judgment I have noted that it does not always capture the sense of what he was saying quite so well and can occasionally be a bit unclear. This is not a criticism of him (he can quite justifiably describe himself as fluent in English, including technical English) or of the shorthand writers, (who were excellent as always), but just a facet of the fact that the transcript cannot capture tone, inflection or non-verbal communication. I mention it so that it is clear that I have taken account of it, and for the information of any appeal court.

ETSI experts

24. Optis' ETSI expert was Ms Johanna Dwyer. She worked for RIM/Blackberry for many years, and from 2005 until 2012 she was involved in various aspects of standards and IP. She participated in various 3GPP WGs and TSGs. She worked on IPR declarations and held senior positions in relation to system standards. Following an MBA in 2012 she has worked in more business-focused and consultancy roles, still very largely in cellular communications. She has given evidence in the Eastern District of Texas proceedings between the parties.
25. Apple criticised Ms Dwyer during her oral evidence for paying too little attention to the second sentence of Clause 4.1 of the ETSI IPR POLICY and too much to the first sentence. It did not pursue this criticism with much force in closing, and I am not surprised, given that it had itself shifted focus back towards the first sentence. In any event, it was not a criticism that could possibly affect my overall assessment of her evidence, which is that she was an excellent, well qualified witness who supported her opinions with careful and complete analysis of the facts. I thought she was particularly helpful and reliable in relation to how the ETSI declaration process worked, how declarants behaved, and whether and if so how it would have been practical for ETSI members to correlate ETSI declarations to individual TDocs.
26. Ms Dwyer was supported by Mr Paul Carpenter, who did the data collection and analysis for her to show how ETSI members behaved over time. He was not required for cross-examination.
27. Apple's ETSI expert was Mr Friedhelm Rodermund. He worked for ETSI from 1998 to 2004. Since he left he has been involved in various capacities with OMA, ETSI, and 3GPP, and since 2017 he has been a delegate to the ETSI IPR Special Committee, which is responsible for the maintenance of the ETSI IPR policy. In

terms of employment, he worked at Vodafone from 2005 to 2014, and thereafter as a consultant.

28. Although knowledgeable about ETSI and its processes, I found Mr Rodermund much less practical than Ms Dwyer and much less sound on the detail. This may be a function of his actual experience with ETSI, but it was certainly a function of how he understood his task. He did not consider the actual behaviour of ETSI members. His analysis was based on his own analysis of what clause 4.1 meant, and a theoretical consideration of how a system requiring immediate declaration of patent applications written onto TDocs would work. For example, he considered at a theoretical level how a WG member might seek to find out that a TDoc was covered by a patent application if all (which is far from being the case) such applications were fully and immediately declared.
29. In terms of how ETSI members actually behaved, I accept Ms Dwyer's evidence since Mr Rodermund did not deal with it. In terms of the practical question of whether it was *really* possible for WG members to find out whether a TDoc was *actually* covered by a patent application, Ms Dwyer was by far the more careful, rigorous and realistic witness, and her evidence was based on the real-world facts.
30. Optis went further and criticised Mr Rodermund as a partial, unbalanced witness who lacked independence and was an advocate for Apple. It supported these criticisms with examples where it said Mr Rodermund had quoted selectively. It was reasonable to explore and make these points and there was force in them (although I thought they related only to his written evidence, since his oral evidence was straightforward and fair), but not so much as Optis contended. The real problem was the scope of what he had been asked to do, which was to provide materials supporting a view that his understanding of clause 4.1 could work, and that there were policy views, held by some, that it was how the clause ought to work. It was an extremely abstract, theoretical approach and I do not think that it engaged with the issues for decision by me. To give an example, Mr Rodermund was criticised with particular force for not acknowledging in his evidence here, the reports Ms Dwyer had submitted in the Texas proceedings about ETSI members' actual behaviour. He simply had not done that because he had not been asked to, but he had not concealed it at all. Another example was in relation to whether IP was discussed by Working Group members prior to, or at, their meetings: Mr Rodermund found some materials where it appeared that that might have happened, but on examination they did not hold water. He was again, I felt, concerned with the theoretical and not the actual.
31. In any event, on the facts of what ETSI members did and what they could do in connecting TDocs with IP, I prefer Ms Dwyer simply because she was by a considerable margin the better witness.
32. Apple submitted a CEA Notice from another potential expert, Mr Michael Walker, now sadly deceased. I directed at the PTR that the evidence could only be relied on for primary facts, not opinion. Apple essentially ignored my ruling and inserted significant sections of opinion evidence from his reports into its skeleton argument in opening. Optis understandably objected. I have ignored the evidence.

THE SKILLED ADDRESSEE

33. There was no material dispute about this in general terms. The skilled addressee would have a number of years of practical experience working on the RLC layer.
34. Since the Patent teaches that its invention is of utility for a wide range of standards including UMTS and LTE, both are relevant.
35. UMTS at the priority date was a standard which was live and in full commercial operation and the skilled addressee would therefore have gained hands-on experience.
36. Because LTE was still in development the skilled addressee's knowledge would have to be based on the ongoing standardisation work. However, they would not necessarily be an attendee at LTE standardisation meetings (a potential dispute along the lines of the decision of Arnold J, as he then was, in *Philips v. Asustek* [2018] EWHC 1224 (Pat) at [148]-[151] as to the precise degree of involvement in standard setting did not materialise and would not matter).
37. It is to be borne in mind that the skilled addressee is a single, notional person; a legal construct. It is clear that in real life there were some engineers in this field who preferred windows-based solutions and other who preferred counter-based solutions. That does not make it legitimate to argue that the patent would or would not be obvious to one or other such type of engineer. The notional skilled addressee would be aware of the differing views and reasons for them, to the extent that such were CGK. In the end this played a very small part in the obviousness case, though.

THE COMMON GENERAL KNOWLEDGE

38. There was no dispute as to the applicable legal principles: to form part of the common general knowledge ("CGK"), information must be generally known in the art, and regarded as a good basis for future action.
39. At my request the parties submitted a document setting out the agreed matters of CGK, which forms the basis of the next section of this judgment and which I have edited slightly; where I have removed material it is because I think it of low relevance, not because I disagree with it. It is closely based on the judgment of Birss J in the previous action, not because that has any special status (I have held that it does not) but because it was a convenient source that was at the right level of detail.

Agreed common general knowledge

40. Mobile telecommunications systems consist of a fixed network within which a mobile handset (User Equipment or UE) may move around. The fixed network is formed of two parts. There is the core network which links to the Public Switched Telephone Network (PSTN) and also links to the internet. Then there is the radio access network (RAN) which comprises radio transmitters and links to the core network and mobile handsets over the air interface.

41. By the priority date mobile networks were digital and sent at least some types of information in “packets” – that is as groups of bits. The term packet switched network drew a distinction from older digital mobile phone networks like GSM which were (originally) circuit switched. In a circuit switched network only a single information stream could use a communication channel at one time.
42. In order to operate by sending and receiving packets, each data stream has to be split up into packets for transmission and once received the packets must be reassembled into the data stream. To recreate the data stream with complete fidelity the receiver has to reassemble all the right packets, necessarily, in the right order.
43. Packet switched communication requires that the packets are temporarily stored at the transmitter and the receiver. The receiver must temporarily store the packets because they have to be received in their entirety before they can be processed properly. The transmitter must temporarily store packets because there is a possibility that the packet may be required to be retransmitted if it was not received.
44. Digital mobile telephony took off with the GSM system. This was known as a second generation or 2G system (1G referred to analogue networks). The first packet switched network in general use was the GPRS part of the GSM standard, known as 2.5G. This was followed by a 3G system known as the Universal Mobile Telecommunications System (UMTS). UMTS was the generation currently in use at the priority date. UMTS used packet switched services for web browsing, but circuit switched services for voice calls. Work on 4G had already commenced at the priority date. That standard was known as Long Term Evolution (LTE). LTE was to be the first fully packet switched network.
45. One of the significant drivers in the development of the different generations of mobile networks was consumer demand for access to the internet at increasing data rates. The backbone of the internet is a wired network (for this purpose “wire” includes fibre optic cable). As a wired network, transmission errors are relatively rare, in contrast to the error rates over the air interface in a mobile network. The latter occur relatively much more frequently and so packet switched systems have to be designed to include error detection and correction mechanisms on the air interface to make their behaviour more like that of the wired network.
46. In order for two devices to communicate they need a set of rules which defines the semantics, syntax and sequencing of messages passing between them. That is a communications protocol. A very familiar idea in 2008, dating back to the OSI model in the 1980s, was a protocol layer stack. This allows different types of protocols to be used concurrently yet independently. Entities at the same layer in the stack communicate with each other with a defined protocol without having to be concerned about the protocols between entities at lower layers in the stack. For example an entity such as a computer game program running on a phone may wish to communicate with its peer entity in a computer hosting a website somewhere on the internet. The computer game has a protocol for communicating with the website but it does not need to know how to communicate over the air interface. That is taken care of by lower layer entities

in the protocol stack. To send a message the transmitting entity in the phone passes the message down to lower layer entities in the phone. At the lowest, physical, layer the message is sent across the radio link to a base station. Once the message is received in the base station, it may then be sent via different physical layer protocols to the core of the mobile phone network and from there, via other lower layer protocols it may be sent across the internet to the website. So higher layer entities can communicate with each other without being concerned with how the lower layer protocols work.

47. From the point of view of an entity at a given layer in the stack, a packet of data received from a higher layer is called an SDU (service data unit) while the data sent down to a lower layer is called a PDU (protocol data unit). In general an entity which receives an SDU from a higher layer which is to be transmitted on to a lower layer adds its own layer control information to the packet in the form of a header. The SDU is untouched and treated as payload. The fact that the payload probably contains headers from higher layer entities is irrelevant. Once the packet, consisting of the SDU plus header, is passed down as a PDU, the lower layer receiving entity treats what it has received as an SDU. This lower layer entity may add its own header too. When the data is received the process is reversed as the data moves up the stack. This process is illustrated in the following diagram:

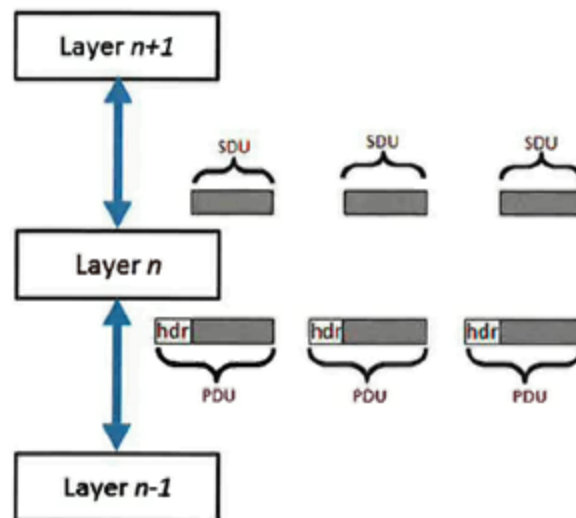

Figure 6 – OSI protocol stack layer concept

48. Web browsing over the internet utilises the HyperText Transfer Protocol (HTTP) protocol as its highest layer. Below that are layers called the Transmission Control Protocol (TCP) and the Internet Protocol (IP) (known together as TCP/IP). TCP/IP is designed to operate on a wired network and if it was used over the air interface it would involve transmission of an unacceptably high level of control information. Therefore, the UMTS protocol stack utilised a layer known as Packet Data Convergence Protocol (PDCP) which compressed the data from TCP/IP to an acceptable level. In addition, TCP/IP assumes a relatively error free packet stream. The way TCP/IP responds to errors is by reducing throughput, at least in part because any errors which do occur are assumed to arise

from congestion. However that is not what causes errors in the air interface and so, in the context of mobile telephony, the TCP/IP response to errors would be counter-productive. Accordingly, UMTS uses a protocol called Radio Link Control or “RLC”, which sits below PDCP, in order to try and ensure that TCP/IP experiences sufficiently error free data stream in appropriate circumstances. The layer below RLC in UMTS is the Medium Access Control (MAC) layer. It sits between RLC and the physical layer, and is designed to share transmission resources between multiple RLC processes. It multiplexes multiple data bearers into a single data stream. Transport blocks are transmitted over the air interface at intervals known as a Transmission Time Interval (TTI).

49. In UMTS prior to Release 7 in 2007 the RLC PDUs were of fixed size. Their relationship with SDUs from the higher layer was arbitrary i.e. if an SDU was too long, it was segmented, if too short, it could be concatenated with other SDUs. This is illustrated in the diagram below:

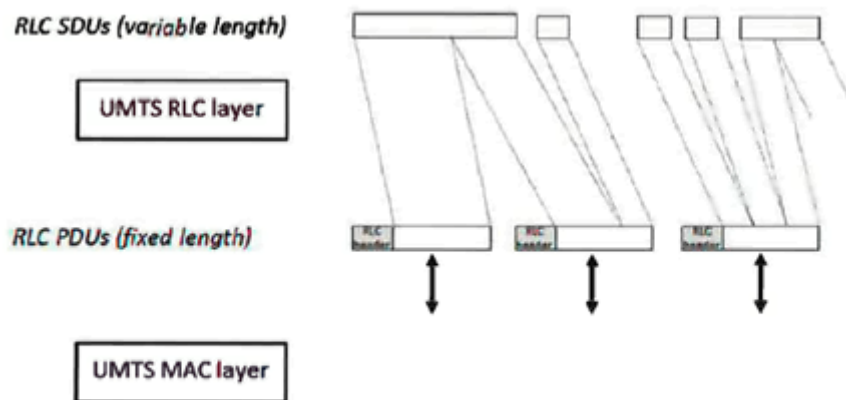

Figure 16 - UMTS-HSPA: mapping of RLC SDUs to RLC PDUs

50. Release 7 of UMTS introduced flexible PDU sizes. These were used in the downlink (from network to mobile) and could be up to 1500 bytes.
51. The RLC protocol in UMTS employed something known as an automatic repeat request protocol or “ARQ”. When PDUs are sent from the transmitting entity, the receiving entity acknowledges PDUs that have been received correctly. The acknowledgement is referred to as an “ACK”. The receiver may also send a negative acknowledgement message for missing or erroneous PDUs to the extent that it can detect that this has happened. The negative acknowledgement is called a “NACK”. One could imagine an arrangement in which each PDU has to be acknowledged before the next is sent. This is called a “stop and wait” protocol. The problem with it is that the transmission channel remains idle in the meantime and so is under used. This is inefficient and introduces a high overhead. There has to be at least one status message for every transmitted PDU.
52. More sophisticated ARQ systems use a sliding window. The system allows for the ability to transmit a limited number of new PDUs without having to wait for an acknowledgement of the last PDU. Each PDU is assigned a “sequence number”. This allows the receiver to know which PDUs have been received and which are missing. It also allows the status report to identify which PDUs are

being acknowledged as received (“ACKed”) and which are missing and are being “NACKed”. The sequence number also allows the receiver to reform the data stream into the correct order. There is a “transmitter window” of the number of PDUs which can be transmitted but not yet acknowledged. When the oldest PDU in the transmitter window is acknowledged, it is removed and the window moves, or slides, along.

53. The use of sequence numbers introduces an additional overhead because each PDU has to include this number in the header. However this is worthwhile as it enables several PDUs to be ACKed (or NACKed) together, thus reducing the number of ACK / NACK messages being sent on the reverse channel back from the receiver to the transmitter.
54. The number of possible sequence numbers is not infinite. For example if 9 bits are used for the sequence number, that gives 512 possible values. As long as no more than half the available numbers are used at any one time, the system will be robust to data loss in both directions. So for 512 possible values, the window of available numbers would be 256. The sequence numbers would be cyclic and wrap around from 511 back to 0. If the earliest unacknowledged PDU is sequence number 100, the window of available sequence numbers will be up to 355. If all the available sequence numbers are used up a stall occurs. At that point no more new PDUs can be sent since they would need new sequence numbers. In that sense the sequence number is a finite resource. In order to free up available sequence number resources, status reports from the receiver are needed. So in the example given, if the sequence number of the currently transmitted PDU had reached 355 the system would stall. If then a status report was received which ACKed PDUs with sequence numbers from 100 up to 229, the window would move forward to the span 230 – 485 and transmission could restart.
55. In UMTS, 12 bits were used for the sequence number so that the numbers would wrap around from 4095 back to 0, and, in practice, the maximum size of the sliding window was 2048 sequence numbers.
56. Using this method, once a PDU has been sent the transmitter has to keep it in case it needs to be retransmitted. The data is stored in the “retransmission buffer”. The ability to retransmit a given PDU has to be preserved until that PDU has been acknowledged. Thus a status report frees up two resources, sequence numbers and buffer memory. Once a PDU has been ACKed, it can be deleted from the retransmission buffer.
57. From the example explained, one can see that instead of stalling, waiting for a status report and then restarting, it would be better to try and arrange things so that status reports come into the transmitter before the system stalls.
58. The receiver can decide to send a status report itself. If a PDU is missing from the sequence, the receiver can tell that this has happened from the sequence numbers. This is called “gap detection”. The system can be arranged so that a receiver which detects a gap sends a status report. The report will NACK the missing PDU and ACK the PDUs which have been received. In UMTS, a timer can additionally be configured by upper layers to cause a status report to be sent once the timer has elapsed.

59. When the system is operating well with few errors the transmitter may need to be able to poll the receiver to request a status report so that it can move the window forward. The different polls are characterised by what triggers them. There are end of transmission polls, which are not directly relevant but were referred to in the evidence. The relevant polls in this case apply in the course of continuous transmission. In general the way a poll is requested is by setting a bit in the header of a PDU. Thus when the receiver receives that PDU and finds the poll bit set, it knows to send a status report. One of the factors which has to be taken into account is that, given the errors on the air link, the PDU which contains the set poll bit might be lost in transmission and not received by the receiver and conversely, a status report sent by the receiver may not be received by the transmitter.
60. The UMTS standard relating to RLC which was current at the priority date was 3GPP TS 25.322 V7.5.0. It defined a series of possible poll triggers which the implementer could use. The RLC has a number of modes of operation and the relevant definition applies in “acknowledged mode” or AM. Acknowledged mode is the mode to use when dealing with email and web access, aiming to keep packet loss to a minimum but accepting that some packets may be received out of sequence. In acknowledged mode the PDUs are called “AM PDUs” or “AMD PDUs”.
61. The available triggers in the UMTS system were referred to in evidence as a “tool box”. They included end of transmission polls: “Last PDU in buffer” and “Last PDU in Retransmission buffer” which are self explanatory. The defined polls also included the following (at paragraph 9.7.1 of 3GPP TS 25.322 V7.5.0):
- i) “*Poll timer*”. A timer is set when a poll is triggered and stopped in certain circumstances (such as when the right status report is received). If no status report appears before the timer runs out a further poll is sent. This aims to ensure that when a poll is sent, it is answered correctly.
 - ii) “*Every Poll_PDU PDU*”. This is a PDU counter. The system counts the number of PDUs sent and when that number reaches the value in the field “*Poll_PDU*” a poll is triggered.
 - iii) “*Every Poll_SDU SDU*”. This is an SDU counter. The system counts the number of SDUs received and when that number reaches the value in the field “*Poll_SDU*” a poll is triggered. To be precise the poll is triggered on the first transmission of the AMD PDU which contains the last segment of the RLC SDU.
 - iv) “*Window based*”. This triggers a poll when the parameter “J” reaches a threshold. The parameter J is defined as:

$$J = \frac{(4096 + VT(S) + 1 - VT(A)) \bmod 4096}{VT(WS)} * 100$$

J represents the percentage occupancy of the sequence number window at the transmitter. A poll is triggered for each AMD PDU where $J \geq \text{Poll_Window}$. The term “ $(4096 + \dots) \bmod 4096$ ” accounts for the fact that

in UMTS sequence numbers wrap around to zero after passing 4095, and the “+1” term is for the next PDU to be transmitted.

- v) “*Timer based*”. This triggers a poll periodically based on a timer.
62. The triggers in the toolbox were there to be selected by an implementer. No-one would expect all these triggers to be used in the same system at the same time.
63. The purpose of these triggers, particularly the counters (ii) and (iii) and the window based and timer based triggers (iv) and (v), is to poll periodically during continuous AM operation so as to avoid stalling.
64. The window based approach (iv) keeps track of the percentage of the sequence number resource which has actually been used and therefore what is available. This is more complicated to implement but more accurate than a PDU counter (iii).
65. The efficiency of the system involves a balance. Stalling is very inefficient and too few polls increase the risk of a stall. But too many polls are also inefficient since the status reports they generate use up bandwidth (the poll requests themselves do not use up bandwidth because they just involve setting a bit in a PDU which is to be sent in any event). The problem of too many polls was known as “superfluous polling”. In the same paragraph of the UMTS standard (9.7.1) there is a reference to the Poll Prohibit function. Its purpose is to mitigate the problem of superfluous polling. The function works using a Poll Prohibit Timer (paragraph 9.5(b)) which is a timer which starts counting time when a poll is sent. Until the set period has expired any further polls are prohibited. If polls are triggered during this set period which would have been sent but for the Poll Prohibit Timer, these polls are delayed, with one poll being sent on expiry of the Poll Prohibit Timer.
66. In the receiver a status prohibit timer played a similar role to the poll prohibit timer in the transmitter. The status prohibit timer prevented transmission of status reports if one had recently been sent. When the status prohibit timer expired a status report would be sent if any were triggered while it was active.
67. TS 25.322 V7.5.0 provided at its section 9.4 a list of state variables which the transmitter was required to maintain. The most relevant ones are set out below:

i) VT(S) - Send state variable.

This state variable contains the "Sequence Number" of the next AMD PDU to be transmitted for the first time (i.e. excluding retransmitted PDUs). It shall be updated after the aforementioned AMD PDU is transmitted or after transmission of a MRW SUFI which includes $SN_MRWLENGTH > VT(S)$ (see subclause 11.6).

The initial value of this variable is 0.

ii) VT(A) - Acknowledge state variable.

This state variable contains the "Sequence Number" following the "Sequence Number" of the last in-sequence acknowledged AMD PDU. This forms the lower edge of the transmission window of acceptable acknowledgements. VT(A) shall be updated based on the receipt of a STATUS PDU including an ACK (see subclause 9.2.2.11.2) and/or an MRW_ACK SUFI (see subclause 11.6).

The initial value of this variable is 0. For the purpose of initialising the protocol, this value shall be assumed to be the first "Sequence Number" following the last in-sequence acknowledged AMD PDU.

iii) *VT(PDU)*.

This state variable is used when the "poll every Poll_PDU PDU" polling trigger is configured. It shall be incremented by 1 for each AMD PDU that is transmitted including both new and retransmitted AMD PDUs. When it becomes equal to the value Poll_PDU, a new poll shall be transmitted and the state variable shall be set to zero. The initial value of this variable is 0.

iv) *VT(WS) – Transmission window size state variable*.

This state variable contains the size that shall be used for the transmission window. VT(WS) shall be set equal to the WSN field when the transmitter receives a STATUS PDU including a WINDOW SUFI.

The initial value of this variable is Configured_Tx_Window_size.

68. It was common ground that UMTS, and in particular the above aspects of it, were common general knowledge. It was also common ground that the skilled person would refer to the standard specifications and draft specifications in existence at the priority date which applied to the UMTS and LTE systems. These specifications were common general knowledge. As LTE was still in development as at the priority date, the skilled person would be well aware of the document 3GPP TS 36.322 V.8.0.0 which was under change control and could only be changed by formal change requests with the approval of the 3GPP working group and plenary group. Although it was only published in December 2007, shortly before the priority date, the skilled person would know it existed, know what it was and where to find it if they were interested.
69. The development of LTE took UMTS as a key starting point. The particular aspects of LTE which were common general knowledge and which have a bearing on this case were the following.
70. One significant structural difference between LTE and earlier generations was that LTE simplified the network architecture by combining what had been the separate entities of the Radio Network Controller (RNC) and the base station into a single entity. That single entity was referred to as the eNodeB. Putting functions together into the eNodeB enabled close coupling between ARQ and an additional error correction process known as "HARQ".

71. Like Release 7 of UMTS, LTE provided for RLC to use variable size PDUs. In LTE this was for both the uplink and the downlink. In LTE the RLC was to provide variable size PDUs depending on how much capacity was available for that particular RLC process in the current transmission interval and the range of sizes was much greater than for UMTS. This is fundamentally different from earlier releases of UMTS where the RLC PDU size was fixed. The below diagram illustrates the variable sized PDUs in LTE:

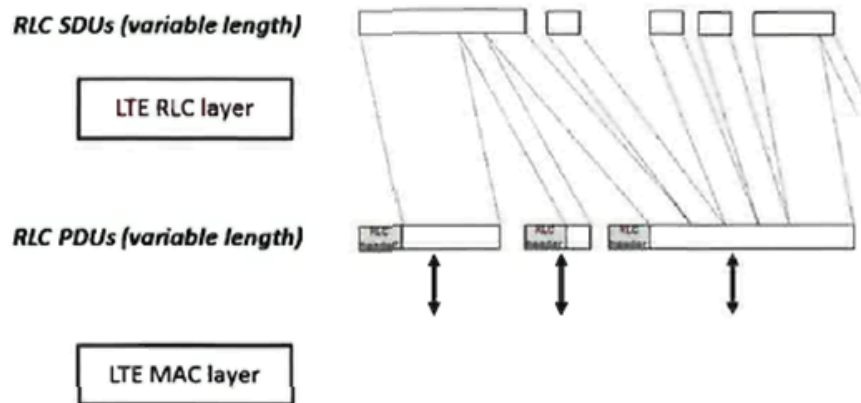

Figure 17 - LTE: mapping of RLC SDUs to RLC PDUs

72. A complication with having variable sized PDUs is that if a PDU is lost and needs to be retransmitted, the transmission opportunity which arose at the time of retransmission may not permit PDUs as large as the one which was lost. Thus it was agreed that LTE would allow for PDUs in that case to be broken up into segments and the segments transmitted separately. This process was called segmentation or re-segmentation.
73. In LTE, 10 bits were used for the sequence number so that the numbers would wrap around from 1023 back to 0, and the size of the sliding window was fixed at 512 sequence numbers.
74. A problem created by variable sized PDUs in Release 7 of UMTS and LTE is that the storage space needed in the retransmission buffer for unacknowledged PDUs is no longer directly related to the number of unacknowledged PDUs and so a stall can now be caused by two distinct phenomena: the transmitter could run out of sequence numbers but separately it could run out of storage space in the retransmission buffer. How to deal with this problem is what this case is about.
75. The other significant feature of LTE which was common general knowledge at the priority date was the desire to simplify the system as compared to UMTS. UMTS was regarded as complex and those working on LTE were aiming to produce a simpler system. The toolbox of polling triggers in UMTS was one aspect which the skilled person wanted to simplify.
76. The LTE RLC specification TS 36.322 V8.0.0 defined the following two polling triggers (in section 5.2.2):

- i) Transmission of last data in the buffer.
- ii) Expiry of poll retransmit timer.

77. This section also included an Editor's note in the following terms:

“Editor's note: It has been decided to support either PDU count based polling trigger or Window based polling trigger in addition [sic] to the polling triggers indicated above.”

78. In LTE in addition to status reports triggered by a poll request, status reports could be triggered by detection of a missing PDU or an indication from upper layers, although the detailed operation of these mechanisms was not included in TS 36.322 V8.0.0.

79. Section 5.2.3 of TS 36.322 V8.0.0 included an Editor's note in the following terms:

“Editor's note: The need for a status prohibit function has been agreed, but the exact mechanism is still FFS [for further study]”.

Disputed and potentially disputed common general knowledge.

80. I have set out the agreed CGK above. Because the parties were working on their closing written submissions in parallel with reaching that agreement, their closing written submissions listed some things as disputed which in fact were not.

What was and was not disputed

81. The parties identified the areas of disagreement on the CGK as lying in the following areas:

- i) The nature of counter-based and windows-based polling. I do not think this was really an issue about CGK, since both counter-based and windows-based polling are agreed to have been CGK at the level indicated above. There is a significant dispute about the different consequences of the two approaches, which I will address in connection with the prior art.
- ii) Sliding windows, windows-based operation, the J-equation: these were identified as potentially disputed by Apple, but they were not disputed and are covered in the agreed document.
- iii) Stalling and causes of stalling: likewise, these were identified as potentially disputed by Apple but were not.
- iv) Poll prohibit timers and status prohibit timers: there was a dispute about this and I address it below.
- v) Scheduling algorithms, round trip times and whether it was realistic for no further PDUs to be transmitted between poll trigger sending and receipt of a status report: these go together and I will address them below.

- vi) “The direction of the art”. Mr Kubota presented in evidence an analysis of TDocs which were said to show a preference in the art for window-based polling over counting-based. Depending on the view one takes, this was either “mindset” material, or secondary evidence of non-obviousness in relation to InterDigital. I will deal with it in connection with InterDigital.

Poll prohibit timers and status prohibit timers

82. It is common ground that these were known and CGK in UMTS. It is also agreed that it was CGK that there would be a status prohibit timer in LTE but that details were for further study. However, it was disputed whether or not it was CGK that it had been decided that there would not be a poll prohibit timer in LTE. The relevance of this lies in whether a poll prohibit timer could potentially be used in the context of a counter-based adaptation of InterDigital.
83. Apple contended that it was CGK that there was a positive decision against a poll prohibit timer in LTE, founding its submission on Mr Kubota’s written evidence. I reject the submission because it involved a misreading of Mr Kubota’s evidence – he said that there was greater support for a status prohibit timer, and although he cited one document which stated that there was a decision against a poll prohibit timer, he did not say that that was final, or CGK.

Scheduling algorithms, round trip times, no further PDUs

84. This aspect of CGK is a rather unusual one; what it ultimately goes to, in the context of the anticipation arguments over InterDigital, is whether it was possible/usual/realistic for a situation to arise in UMTS where, following the sending by the transmitter of a poll request in a PDU, a status report could be sent back by the receiver and arrive at the transmitter (making a “round trip”) before the transmitter sent another PDU.
85. This involves a comparison of the “round trip time”, also known as “RTT”, with the frequency with which the transmitter would, or could, send PDUs.
86. Apple argued that such a situation could arise. It accepted that it was less common than a situation where further PDUs were sent before receipt of a status report, but not an unrealistic scenario. Optis argued that it was a possible situation, but a rare one, a “corner case”.
87. In terms of actual CGK, I hold, and there was little dispute, that the RTT varied quite a bit, and could be as short as about 13 ms.
88. As to how long a transmitter might go between sending successive PDUs, Apple sought to argue that it could be quite long, longer than the RTT, if a sort of rationing called “Proportional Fair” was used, which allowed the network in UMTS to slow down individual UEs in their transmission, depending on resource availability. It put to Mr Kubota a section from a well-known UMTS textbook. He and Optis accepted that Proportional Fair was CGK.
89. However, the point does not end there because, as Mr Boué-Lahorgue accepted, the fact that Proportionate Fair allows for a delay time longer than the RTT would

only lead to a situation of no-more-PDUs if the decision to implement the Proportionate Fair happened to be made in the interval between a poll being sent and the status report being received. However, the questioning did not go so far as to suggest to Mr Boué-Lahorgue that this was so unlikely as to be entirely unrealistic.

90. I hold that:

- i) RTTs as short as about 13ms were CGK.
- ii) Proportional Fair was CGK, and it was CGK that it could involve delays considerably longer than such short RTTs.
- iii) The coincidence of short RTT and use of Proportional Fair to such a degree and with such timing as to lead to a no-more-PDUs situation would be rare but not entirely unrealistic.
- iv) However, there is no evidence that that situation was ever thought about, let alone part of the CGK.

THE PATENT

91. The patent begins with the following introductory paragraph:

“**[0001]** The present invention relates to a method and an arrangement in a first node comprised in a wireless communication network. In particular it relates to a mechanism for Radio Link Control (RLC) polling for continuous transmission within the wireless communication network.”

92. Then, at [0005] to [0007] it sets out aspects of the draft LTE standard as it stood at the time, including two criteria for setting the poll bit:

“**[0005]** The RLC protocol applied in an evolved UTRAN (E-UTRAN), also denoted Long Term Evolution (LTE), has been defined in the document 3GPP TS 36.322 "Evolved Universal Terrestrial Radio Access (E-UTRA), Radio Link Control (RLC) protocol specification Release 8" issued by the 3rd Generation Partnership Project (3GPP). The RLC protocol includes a polling procedure that transmits polls according to a number of criteria. When a poll is triggered the RLC transmitter will set a poll bit in the RLC header, the poll bit serving as a request for a peer entity to send an RLC status report. Currently agreed criteria for setting the poll bit are:

[0006] Firstly, transmission of last Protocol Data Unit (PDU) in a buffer, i.e. a poll is sent when the last PDU available for transmission or retransmission is transmitted.

[0007] Secondly, the expiry of a poll retransmission timer, i.e. a timer is started when a PDU containing the poll is sent and the PDU is

retransmitted if the PDU with the poll bit is not acknowledged when the timer expires.”

93. At [0008] it explains that for continuous transmission, additional triggers may be needed to prevent protocol stalling, and refers to the possibility of using counter-based or window-based mechanisms, operating on PDUs or bytes.

94. It then compares counter-based and window-based mechanisms at [0009] and [0010]:

“**[0009]** A counter-based mechanism counts the amount of transmitted PDUs, or bytes, and sets the poll bit when a configured number of PDUs, or bytes, have been transmitted.

[0010] A window-based mechanism is similar but transmits the poll only when the amount of outstanding data exceeds a certain number of PDUs, or bytes. A window-based mechanism may need additional logic to transmit the poll regularly as long as the amount of outstanding data exceeds the threshold.”

95. And at [0012] it asserts that no existing mechanisms take into account that stalling can arise sometimes from sequence number limitations and sometimes from memory limitations.

96. After some consistency clauses, there is a reference to the way in which the teaching of the Patent can avoid superfluous polling, at [0017]:

“**[0017]** Thanks to the present methods and arrangements, superfluous polling due to both sequence number limitation and memory limitation is avoided by help of one single mechanism. By combining the two criteria "transmitted number of data units" and "transmitted number of bytes" into one mechanism, it is avoided that a poll is unnecessarily sent when the first criterion is fulfilled in situation when such a poll has already recently been triggered due to the other, second criterion. Thus unnecessary signalling between the nodes comprised within the wireless communication system is reduced, which leads to reduced overhead signalling and thereby increased system capacity. Thus an improved wireless communication system is provided as a consequence of the present improved mechanism for polling within the wireless communication network.”

97. There are four figures. For the purposes of this trial and this judgment, it will only be necessary to refer to Figure 2, which is a combined signalling scheme and flowchart, and to Figure 3, which is an illustrative flowchart. Although the Figure 3 flowchart could be performed by going through each step just once, it is clearly to be envisaged that it would be done repeatedly.

98. I will set out further details of Figure 2 and Figure 3 and the accompanying narrative below; they are important to claim construction, especially of claim 9.

99. The narrative of Figures 2 and 3 is very cumbersome, but nothing turns on this in itself.
100. In various places, the Patent emphasises its intention not to be bound narrowly, or to the preferred embodiments. I deal with this further below.

Claims in issue

101. Claim 1 of the Patent (broken into integers, taken from Apple's opening skeleton with some typos corrected and the italicisation, on which nothing turns, reinstated) is:

(a) Method in a first node (110) for requesting a status report from a second node (120), the first node (110) and the second node (120) both being comprised within a wireless communication network (100),

(b) the status report comprising positive and/or negative acknowledgement of data sent from the first node (110) to be received by the second node (120), wherein the method comprises the steps of:

(c) *transmitting* (306) a sequence of data units or data unit segments to be received by the second node (120), the method further comprises the steps of:

(d) *counting* (307) the number of transmitted data units and

(e) the number of transmitted data bytes of the transmitted data units, and

(f) *requesting* (310) a status report from the second node (120)

(g) if the counted number of transmitted data units exceeds or equals a first predefined value, or the counted number of transmitted data bytes of the transmitted data units exceeds or equals a second predefined value.

102. Claim 6 (also broken into integers) is as follows:

(a) Method according to any of the previous claims 1-5, further comprising the steps of:

(b) *resetting* (311) the first counter (421) to zero, and

resetting (312) the second counter (422) to zero.

103. Claim 9 is then as follows:

(a) Method according to any of the previous claims 6-8,

(b) wherein the steps of resetting (311, 312) the first counter (421) and the second counter (422) is performed

(i) when the first predefined value is reached or exceeded by the first counter (421)

or

(ii) when the second predefined value is reached or exceeded by the second counter (422).

104. The emphasis on “or” is not in the original but helps direct attention to the word, which is a key issue on claim construction.

Proposed amended claims:

105. Proposed amended claim 1 adds two references to LTE. Proposed amended claim 12, which is a product claim to a first node, adds the requirement of the node’s arrangement “being adapted for use in LTE”. It is not necessary to set them out.

106. The proposed amendments only seek to deal with novelty. They do not have any relevance to obviousness.

CLAIM INTERPRETATION

107. The parties were fundamentally in disagreement about the meaning and scope of the claims. Such was the depth of their disagreement that they did not even consistently identify which words or phrases were in issue, or in which claims. Their arguments were very different in opening than in closing. This has made the preparation of this judgment quite difficult. I think I can best proceed by first answering the most fundamental question, which is what “counting” means in claim 1. Doing so seems to me to answer most if not all of the other questions which arise in relation to claims 1, 6 and 9 over InterDigital, by whatever labels the parties identify them.

108. There is a further, discrete issue of construction over claim 9 (the meaning of “or” in its last line) which is significant for anticipation by Pani and obviousness over InterDigital.

“Counting”

109. This is an ordinary English word. It was not a term of art, but it is certainly very heavily flavoured by context, in this field and indeed in the Patent.

110. Paragraphs [0009] and [0010] of the Patent discuss counter-based and window-based mechanisms in such a way as to contrast them. The paragraphs refer to similarities and differences, as is clear from the words “similar but” in the first line of [0010].

111. The mechanisms are similar in relation to the events which drive them, including in particular the transmission of PDUs and bytes. They are also similar in relation to what they seek to achieve, at a high level: prevention of protocol stalling. These similarities are identified in [0009] and would be known to the skilled addressee from the CGK.

112. However, a basic *difference* is that the window-based approach is concerned with how much data is *outstanding* (in PDUs or bytes). This means it is not merely driven by how much data has been sent (as is the case for counting), but has to have regard to the *current state* of the transmit buffer (again, in PDUs or bytes).

- That in turn depends on the status reports coming back, as well as how much data has been sent.
113. These differences would also be known to the skilled addressee from the CGK. The need to have regard to the current state of the buffer is conveyed by the reference to “outstanding” data in [0010]. This would also clearly convey to the skilled addressee, though does not spell out, the role of status reports.
 114. The second sentence of [0010] then explains the additional complexity of a windows-based mechanism.
 115. If the skilled addressee turned their mind to it, which I doubt they ever would, they would know that the mathematics inherent in a windows-based mechanism to reflect buffer occupancy would require a change every time a PDU was sent, and that that change would reflect one extra PDU being sent, and the number of bytes in it. But they would not regard that as making it the same as a counter-based mechanism.
 116. Another way of looking at this is that counter-based mechanisms operate in units of PDUs and bytes, whereas windows-based mechanisms operate in terms of percentages, because they have regard to how many PDUs or bytes there are in the buffer compared with the maximum PDUs or bytes allowed.
 117. In my view, “counting” in claim 1 is clearly intended to take its meaning from this rather particular context. It means maintaining a count of transmitted PDUs and bytes, in such units.
 118. My conclusion is fortified by the fact that nowhere in the specification is there any reference to the use of status reports such as would be necessary for a windows-based mechanism. I appreciated of course, and take into account, that the claims are not limited to the preferred embodiments, and a working system within the claims might have many other features such as poll triggers. Perhaps there could in the future be a system conceived of that performed “counting” in the sense I have identified and did use status reports. Potentially it could then be in the claim. So the absence of reference to status reports is just a factor lending support to my conclusion.
 119. I also take into account the deliberately inclusive phrasing of the Patent, in paragraphs [0022], [0047], [0058] and [0118]. Some of this is obviously silly, such as the statement in [0058] that the steps of figure 3 can be performed in any arbitrary order. Other parts, such as the statement in [0118] that elements may be “connected” or “coupled” indirectly look like they have been cut and pasted from a mechanical patent without thought. This does not mean that they would not be taken into account, and it would be wrong to allow Optis simply to disown them; they might well have been invoked by it had infringement been in play at some point. But they are not a licence to give a word which was clearly intended to have one meaning, a different one.
 120. Apple relied very heavily on the statement in [0010] that a windows-based mechanisms “is similar” to a counter-based one, but I think it is unfair to strip this one adjective from the context. It is in any event followed by the important word

“but”, setting up the contrast. I do not find the overall language pattern at all difficult: “A tram is similar to but different from a bus. I claim a bus.”

121. Apple relied on some statements from engineers in the field which it said were the use of “counting” in the sense for which it contended. They were made in different contexts and I did not find them helpful.
122. There was also disagreement between the parties as to whether “counting” must take place monotonically, i.e. with the counter changing in only one direction (it was common ground that the counter could count either up or down given e.g. [0087] in the specification). Since the counting is of either bytes or PDUs *transmitted* I agree with Optis that it must be monotonic: it is not possible to *untransmit* and so the counter can only change in one direction.

Claims 6 and 9 – “resetting”

123. This is one of those issues of claim interpretation that is hard to explain without understanding why it matters to the issues.
124. In my view “resetting” means reassigning the counters their previous starting value (in claim 6 this must be zero) as a discrete step which is distinct from their ordinary changes in value resulting from the counting itself.
125. This was Optis’ construction and I think it is the ordinary English meaning, supported by the specification.
126. To give an illustrative example by way of analogy (although all analogies in this case fall apart if pressed very far): if a person were given the daily task of *counting* the net flow of pedestrians into or out of a shopping centre with a manual clicker whose reading could be increased by one for each pedestrian entering, and decreased by one for every pedestrian leaving, Optis would say that the clicker was “reset” at the start of every day when the value zero was put into it without it mattering what the net flow the day before was, but that the clicker was not “reset” if at some point in a day it so happened that the number going in equalled the number leaving, so the clicker showed zero.
127. Apple’s construction was not entirely clear. It said in its written closing that the purpose of resetting was that it “establishes a new origin from which the count is to proceed”. This sounds very similar to Optis’ interpretation and does not appear to cut across the proposition that a reset has to provide a fresh start.
128. However, this apparent agreement masks a dispute about whether a windows-based mechanism, specifically InterDigital, is performing a reset in circumstances that I describe below.

Claims 6 and 9 – timing

129. Apple characterised Optis as arguing that claim 6 requires that the resetting of the counters take place simultaneously with the request for the status report and/or with no intervening steps. Apple says that claim 6 is completely silent about such matters. I agree with Apple.

130. However, I am not sure that Optis did argue any such point on claim 6. By contrast, it certainly did so on claim 9. However, there the language and context is very different, since the claim says that the resetting “is performed when the first predetermined value is exceeded ...” [emphasis added].
131. For reasons explained below, for Apple to succeed on anticipation of this claim by InterDigital, it has to rely on what it says is a reset which does not happen immediately upon the thresholds being reached, but only when a subsequent status report reaches the transmitter. So there are intervening steps and an intervening period of time, during which further PDUs may be sent.
132. It makes much more purposive sense for “when” to mean “at the point in time when” or “immediately upon” (Optis’ construction) than for it to mean “at any time after” or “in consequence of” (Apple’s construction). The reason is that if there is a time lag then a superfluous poll could be triggered during it as a result of further data being transmitted, and it is the object of claim 9 to avoid that.
133. I therefore agree with Optis on this point. I prefer to see it as an issue of whether a time lag is permitted, but it amounts to much the same thing to inquire whether intervening steps/transmissions/status reports are permitted between the threshold being reached and the reset.

Claim 9 – “or”

134. Paragraph [0017] of the Patent is quoted above, with its reference to avoiding superfluous polling.
135. Paragraph [0045] then provides some “pseudocode”, which is a name for logical steps described in a form similar to higher-level human-readable source code which is not in the syntax of any particular programming language:

```

Initialise PDU_Counter and ByteCounter to their starting values;
[transmit data];
IF (PDU_Counter ≥ PDU_Threshold) OR (ByteCounter ≥ ByteThreshold) THEN
  - Trigger a poll;
  - Reset PDU_Counter AND ByteCounter;
END IF.

```

136. Paragraph [0046] then says:
- “**[0046]** The benefit with the above described procedure is that stalling due to both sequence number limitation and memory limitation can be avoided by help of one single mechanism. By combining the two criteria into one mechanism it may be avoided that a poll is unnecessarily sent when a first criterion is fulfilled in situations when such a poll has already recently been triggered due to the other, second criterion.”
137. This has an obvious echo of [0017].
138. Resetting both counters when one hits its threshold prevents superfluous polling because if (say) the byte counter reaches its threshold and both it and the PDU counter are reset, that would prevent an almost immediate further poll which

might have been imminent because the PDU counter was approaching its limit. The same applies the other way around.

139. The greatest benefit in terms of superfluous polling is gained by what, it was common ground, the pseudocode would achieve, which is that both counters are reset when *either* reaches its threshold; both have to be tested against their thresholds.
140. Mr Boué-Lahorgue accepted in evidence that the “or” in claim 9 would be read in line with the pseudocode if the reader took account of the full context of the Patent’s specification, including the pseudocode. This and quite a bit more of the oral evidence was inadmissible argument about the meaning of words, but in any event I agree with it.
141. Optis’ case was that the “or” in claim 9 was intended to achieve the same result as the pseudocode, and that claim 9 was directed to the “single mechanism” referred to.
142. Apple’s case was essentially that the “or” in claim 9 provided an option as to which counter was to be tested, but without requiring that both be. I find it a little hard to articulate how this would be expressed in English without being cumbersome, but the effect was that:
 - i) One option to meet the claim would be to have a method in which only the byte threshold was tested, and both counters reset if it were reached;
“or”
 - ii) Another option to meet the claim would be to have a method in which only the PDU threshold was tested, and both counters reset if it were reached;
143. I think it was Apple’s case that both could be tested.
144. Apple’s argument would have the effect that claim 9 would really be two dependent claims rolled into one – one claim directed to testing the PDU threshold and one claim directed to testing the byte threshold, but neither requiring testing both. This seems a very improbable way of drafting. It is perhaps a facet of the “or means and” point to which I return below.
145. Apple’s main arguments in support of its construction were:
 - i) That there would be a benefit from each option, and the benefit of having a reset if either threshold were met, by testing both, was merely additive. In a general sense this is true (although I do not think it was made good that the benefit of testing both thresholds would be merely additive in a strictly mathematical sense), but it does not mean that the patentee would not want to have a claim directed to the arrangement which maximised the reduction of superfluous polling.
 - ii) That a construction which required both thresholds to be tested would distort the word “or” so that it meant “and”. I found this hard to follow. “Or” can perfectly well be used to mean that something is to be done if

either of two conditions are met: “I take the bus to work if it is raining or if I am late”. This can be rewritten to use “and”: “I take the bus to work when it is raining and when I am late”. In each case I have to turn my mind to the weather and the time to decide whether to take the bus. There was no dispute that “or” was used in that sense (either of two tested conditions) in claim 1, and it is also the sense in which it is used in the pseudocode.

- iii) That it was the literal and ordinary English meaning. I disagree with this for reasons just given.
- iv) That the Patent specification contains a lot of broadening or inclusive language, which extends (see [0086] and [0090]) to making the reset of each counter optional. This is true but does not add anything if, as I find, the reader would think that the meaning of claim 9 was closely informed by the pseudocode. As to [0086] and [0090] specifically, they do not help given that the resets to which they refer are both mandatory in claim 9.
- v) That [0118] contains a definition of “and/or” such that it “includes any and all combinations of one or more of the associated items”. This is not a definition of “or”, but in any case it does not help: there is no dispute that “or” in claim 9 means that the PDU threshold and the byte threshold are both potentially relevant. The dispute is how they are processed in the logic of the method.
- vi) That claim 11 uses “or” in the same way as claim 9. Claim 11 says that the first node “is a base station or a radio network controller ‘RNC’ ... or an evolved Node B, ‘eNodeB’”. This is a false equivalence. Claim 11 is talking about what a physical component used in the method is, when that component cannot be e.g. both an RNC and an eNodeB at the same time.

146. Optis’ arguments are much the stronger. They fit with the ordinary language used, and the intention to have a claim to the specific situation of the pseudocode, to maximise the benefit, is very obvious. I do not think there was anything in Apple’s arguments individually or together. I agree with Optis on this point.

VALIDITY

147. I will deal with anticipation and then obviousness.

Anticipation – the law

148. There was no dispute on the general overarching approach that to anticipate a disclosure must be clear and unambiguous. It must “plant the flag”. Anticipation is distinct from obviousness and “strong” obviousness is not the same as anticipation.

149. There was also no dispute that where a method claim is in issue, what must be disclosed by the prior art is all the method steps of the claim. It is not enough that a prior art method has the same result as the claimed method. Navigation by the stars and by a compass might both result in heading due North, but they are

different methods. Although Apple accepted this principle, its arguments later lost sight of it.

150. Apple reminded me of the decision of the House of Lords in *Merrell Dow v. Norton* [1996] RPC 76 at 88 that an anticipating piece of prior art does not have to have equivalence of language, but of teaching, so that Amazonian Indians would refer to quinine as that which came from cinchona bark while chemists used its chemical name. I agree with this (and I also agree that rearranging a mathematical equation may do no more than describe the same thing in a different way). The question in the present case is the application of this principle.
151. A particular issue on anticipation was presented by Pani, which is a patent application filed before the priority date of the Patent but only published thereafter.
152. Therefore, under s. 2(3) of the Patents Act 1977, matter which Pani contained would form part of the state of the art for novelty, but only if the two conditions of s. 2(3)(a) and (b) were met. S. 2(3)(b) requires that “the priority date of that matter is earlier than that of the invention”.
153. That meant that it was necessary to see if the “matter” in Pani relied on had priority in Pani’s own priority document, which I will refer to as P3.
154. Priority date is dealt with in s. 5. There are many decisions about determining the priority date of an *invention* under s. 5(2)(a), dealing with the concept of “support”. There are far fewer decisions about determining the priority date of *matter* under s. 5(2)(b). I agree with Counsel for Apple (and I do not think Counsel for Optis disputed it) that that merely requires that the matter be disclosed in the earlier priority document: I was referred to *Asahi’s Application* [1991] RPC 485. The disclosure has to be enabling, but that is not in issue in the present case.
155. This means that what I am concerned with in the present case in substance is whether P3 contains matter, i.e. information, that anticipates the Patent’s claims, albeit that the prior art document is in fact Pani.
156. The parties were willing, and indeed preferred, simply to work from P3. This seemed practical to me, and simpler, because it would not involve the labour and possible unnecessary complication of identifying Pani’s teaching and then assessing whether the same thing was in P3. I was concerned in case the approach of working straight from the priority document had been deprecated in the EPO for some reason, where the issue has come up more often. Counsel’s researches did not turn up anything like that, though.
157. Thus the argument proceeded and this judgment proceeds from P3. P3 is accepted to be a less well written document than Pani; indeed Optis agrees that Pani itself would anticipate. Apple stressed that priority documents are often less polished than the applications which follow. I accept this, although what matters is still the information in the earlier document. If the process of polishing adds information, then that cannot be taken into account.

158. More importantly, Apple stressed that the disclosure of the earlier document can include implicit teaching; if there is something that is disclosed by inevitable implication in the earlier document then it is disclosed, and the fact that the later application made the same information explicit cannot alter that. I agree.
159. Apple also argued in its closing written submissions that the prior art document must be considered through the eyes of a skilled reader seeking to understand, not to misunderstand. I agree with this to some extent, and synthetic confusion generated by a patentee seeking to avoid anticipation should be ignored, but in the context of novelty-only art and anticipation it could be pressed too far: if the novelty-only prior art is *genuinely* unclear or ambiguous then anticipation is not made out, and the ambiguity cannot be resolved in favour of the party attacking the patent by arguing that the reader would set about solving the ambiguity by doing tests, or analyses, or thinking about what the best approach within the envelope of uncertainty might be. In other contexts, such as insufficiency, patent law requires the skilled addressee to make practical progress despite a lack of clarity in a document. That is a different matter, and I note that none of the cases cited by Apple was specifically about anticipation. They were about ambiguity under the 1949 Act, or claim interpretation.

Pani/P3

160. P3 concerns enhancements to the RLC protocol in the HSPA+ iteration of UMTS, when one of the changes to be made was the introduction of variable-length PDUs.
161. The parties provided a version of P3 with paragraph numbers added. The paragraph numbers start from 1 on each page. I will refer to them in the format: page/paragraph. The marked up version did not include the claims, and some of those are relied on; I will just refer to them by the claim number.
162. The title of P3, at the top of page 1, is “RLC Enhancements for Flexible RLC PDU size”.
163. Under the heading “Field of Invention”, 1/1 says as follows:

Field of Invention

1. The present invention is related to enhancements for radio link control (RLC) protocol in high speed packet access (HSPA) Evolution where variable RLC protocol data unit (PDU) size is allowed.

164. Apple relies on the references to “enhancements” as part of the picture to emphasise that the document teaches adding things to existing mechanisms, and not replacing them. This is reasonable in itself, but it does not imply a disclosure of anything particular about how the enhancements are to be integrated with the existing mechanisms.
165. Then, under the heading “Background”, 1/2 says:

Background

2. HSPA+ in this document refers to the 3GPP radio access technology evolution of high speed downlink packet access (HSDPA) and high speed uplink packet access (HSUPA), (i.e., enhanced uplink). Some of the major goals of HSPA include higher data rates, higher system capacity and coverage, enhanced support for packet services, reduced latency, reduced operator costs and backward compatibility. Meeting these goals will require evolutions to the radio interface protocol and network architecture.
166. Here, Apple, relies on “backward compatibility”, which would require keeping the capabilities of existing systems and in particular those of UMTS. Again, this does not teach any particular way of combining the new with the old.
167. 1/2 also includes a list of abbreviations, one of which is “LTE – Long Term Evolution”.
168. 1/3 goes on to say:
3. The Layer 2 Radio Interface protocols include MAC and RLC. The main functions of the MAC and RLC protocols are presented here. Note that the MAC and RLC protocols will include other functions just as in legacy systems but are not listed here. The main functions of the MAC protocol are:
 - (1) Channel mapping;
 - (2) Multiplexing;
 - (3) quality of service (QoS) (priority, scheduling, rate control);
 - (4) Link Adaptation (QoS , Multiplexing); and
 - (5) H-ARQ.
169. And this is relied on by Apple as another disclosure that facets of UMTS are to be retained. It is as general as the other references earlier on the page.
170. Some reference was made to 2/1 to 2/4, but neither side put these passages at the forefront of their arguments and it is not necessary to set them out.
171. Under the heading “Summary”, 4/1 provides:

SUMMARY

1. The present invention is related to enhancements for RLC protocol in HSPA Evolution where variable RLC PDU size is allowed. When RLC PDU sizes are not fixed, the RNC/Node-B flow control, RLC flow control and status reporting cannot just depend on sequence numbers (or number of PDUs) as before (with fixed RLC PDU sizes) but need to use byte count-based methods. The enhancements proposed here for the RLC apply to both uplink (UE to UTRAN) and downlink (UTRAN to UE) directions.
172. As well as referring again to “enhancements”, this is a disclosure that developments on top of sequence number/PDU counting would be needed to cope with variable length PDUs. This is taken on by 4/6, which says that:
6. The main aspect of the present invention introduces byte count based methods to enhance the RNC/Node-B flow control, RLC flow control, and status reporting when RLC flexible PDU size is configured with a specified maximum RLC PDU payload size. These enhancements will enable efficient operation of the RLC functions which are currently based on RLC PDU sequence numbers. Moreover the RLC enhancements proposed here apply to:
 - both uplink (UE to UTRAN) and downlink (UTRAN to UE) directions; and
 - the architecture where the RLC is move fully or partially to Node-B

173. This makes clear that byte counting is being proposed. In addition, it is a key area of dispute over whether LTE is disclosed. The expression “the architecture where the RLC is move fully or partially to Node-B” would apply to the flatter architecture of LTE, but the expression “Node-B” is the language of UMTS, as the LTE expression would, strictly speaking, be “eNode-B”.

174. 4/9 then says as follows:

9. With Flexible RLC PDU size using the number of PDUs to define window size will result in variable window size and buffer overflows in the RNC while having potential underflows in the Node-B. Hence, the preferred embodiment includes the following metrics for defining window size when flexible RLC PDU size is configured:
 - Number of bytes
 - Number of blocks where each block is a fixed number of bytes
 - Number of PDUs or Sequence Numbers
 - All possible combinations of the above three metrics

175. This explains that just using the number of PDUs to define window size will not work with variable PDU size because of buffer overflow (and underflow), and the skilled reader would understand this. It provides three parameters for defining window size and says that they can be used in any possible combination. Apple therefore understandably characterises this as a disclosure of the combination of bytes and PDUs/sequence numbers (the first and third parameters). Optis retorts that while that is so, the disclosure is about defining window size, not about what to do with the window generally, or counting in particular.

176. 5/1-2 are as follows:

1. The following preferred embodiments relate to the 3GPP RLC when flexible RLC PDU sizes are supported for AM RLC.
2. To support flexible RLC PDU size in the RRC configuration and reconfiguration of RLC with Radio Bearer Information elements (RLC Info), any of the following information may be included as required:
 - “CHOICE Downlink RLC mode” information including a new indicator for the flexible RLC PDU size mode in addition to the other RLC modes. When flexible RLC PDU size mode is indicated the RLC entities should interpret the other RLC protocol parameters in accordance with this mode as defined later.
 - Any other new information element as part of RLC Info may also be used to indicate the flexible RLC PDU size mode
 - “DL RLC PDU size” information in bits may be re-used and interpreted in flexible RLC PDU size mode
 - as a “RLC Scale” parameter in octets (after dividing number of bits by 8) sent specifically for scaling or multiplying other protocol parameters specified in the number of PDUs as described below. The “RLC Scale” parameter has the same value at the Rx RLC and Tx RLC.
 - as specifying the “maximum RLC PDU size” in the flexible RLC PDU size mode. This “maximum RLC PDU size” may in turn additionally be used as the “RLC Scale” parameter described above.
 - Protocol parameters signaled by upper layers (RRC) to RLC such as, Poll_PDU, Poll_SDU, Configured_Tx_Window_Size, and Configured_Rx_Window_Size (Receiving window size), may be specified and interpreted in two ways:
 - In number of PDUs (SDUs in case of Poll_SDU) or essentially as an integer value, from which the RLC would derive the window size in octets by performing a mathematical calculation. Once such method is to multiply, the specified number of PDUs (SDUs in case of Poll_SDU) or essentially an integer value, with the “RLC Scale” parameter in octets specified by upper layers and described above.
 - In units of bytes ; a new field may be defined for this option to hold the protocol parameter in bytes

177. These discuss in detail information elements/parameters which would be necessary to deal with flexible PDU sizes. It is clear given the context of e.g. 4/6 earlier in the section that there is teaching of information elements/parameters which would be necessary and appropriate for byte counting. Included in the

teaching is the idea of “repurposing” (as Optis put it) Poll_PDU to assess window size as one input to a calculation.

178. A parameter which is not mentioned here (or elsewhere) is VT(PDU); it appears that Apple thought Optis’ case was that that was not disclosed and Apple’s response was that it was necessarily implicit because it would be retained from UMTS even though not spelled out. But in closing Counsel for Optis accepted that VT(PDU) would be retained.
179. Instead, Optis made the same kind of point about these paragraphs as about 4/9 (and about later parts of P3, as I will relate below): that there is no disclosure of doing PDU counting and byte counting in the same method. This was really Optis’ central point, set out in its opening skeleton and maintained thereafter.
180. The section under the heading “Flow Control” at 6/5 was raised in the cross-examination of Mr Boué-Lahorgue but does not take the dispute further for either side.
181. 8/6-7 are as follows:
6. In a preferred second embodiment, the current state variables used for fixed RLC PDU size are maintained and used simultaneously with a set of new variables that deal with the byte count of flexible RLC PDUs.
 7. More specifically, the some of the values maintained in terms of number of PDUs and processed as in the non-enhanced RLC can be:
 - The RLC transmitter state variables
 - VT(S), VT(A), VT(MS), VT(WS)
 - The RLC receiver state variables
 - VR(R), VR(H), VR(MR)
182. The points arising are much the same as for pages 4 and 5: variables previously used for a fixed-PDU arrangement are kept for use with other new ones added to deal with variable-length PDUs. Some specific variables are listed, which again do not include VT(PDU), although as I have said it is accepted by Optis that that would be maintained from UMTS. It is at this point in the argument that Apple relies on the claims of P3, to which I refer below.
183. Optis maintained that this section was still not teaching about a single method using PDU counting and byte counting. Counsel for Optis pointed out that the section heading for these paragraphs (at the end of page 7) is “Enhancement to RLC PDU creation”, stressing *creation*, as opposed to *use*; it is not about status reporting or polling.
184. 9/1 is as follows:
1. The combination of the old and new state variables will allow the RLC to control the windows in terms of maximum amount of bytes allowed and also in terms of maximum number of PDUs allowed (limited by the number of sequence numbers available for transmission).
185. And again the argument is that Apple relies on the addition of new state variables and Optis says that the teaching, while concerning window size, is not of a method which includes counting both PDUs and bytes. 9/1 is still under the heading from the foot of page 7.

186. 9/2, under the heading “RLC Procedure affected by the introduction of flexible RLC PDU size”, says:

RLC Procedure affected by the introduction of flexible RLC PDU size

2. Some of the procedures in 3GPP TS 25.322 V7.1.0 that are updated by the preferred embodiments in order to support and manage tx and rx windows for flexible RLC PDU include the following:
 - Transmission of AMD PDU
 - Submission of AMD PDUs to lower layer
 - Reception of AMD PDU by the Receiver
 - Reception of AMD PDU by the Receiver
 - Receiving an AMD PDU outside the reception window

187. This clearly is talking about changes to methods and not just variables/parameters, but it is too vague to be of any significance.

188. At the top of page 12 there is heading “RLC Status Reporting”. The paragraphs from this section relied on are 12/1, 12/4-5, 12/8-10, and 13/1-2:

RLC Status Reporting

1. The RLC status reports containing acknowledgment information to support ARQ may be triggered in various scenarios by the RLC Tx and RLC Rx entities. We propose that the RLC Tx and RLC Rx entities maintain a mapping of RLC PDU SN and the corresponding length in bytes. This allows the calculation and maintenance of the length of the used flow control window in bytes or other metrics as described above.

...

4. We also need to have the equivalent of “Every Poll_PDU PDU” or “Every Poll_SDU SDU” in terms of bytes, as follows.
5. We propose that the RLC Tx (located in the UTRAN in the downlink and UE in the uplink) may trigger (if configured as such) a status report by setting the “Polling bit” in certain PDUs as follows:
 - RLC Tx maintains a counter of the total number of bytes transmitted in PDUs since the transmission of the last PDU containing a Polling bit;
 - When the counter reaches or exceeds a value (Poll_Bytes), the RLC Tx sets the polling bit in the PDU that makes the counter exceed the value (or optionally, the next PDU after). Then RLC Tx resets the counter.

...

8. Protocol parameter, Poll_Window, signaled by upper layers is used by the transmitter to poll the receiver when “window-based polling” is configured by upper layers. A poll is triggered by the transmitter for each AMD PDU when K is greater than or equal to the Poll_Window, where K is the transmission window percentage defined as:

$$K = \text{utilized_window} / \text{Maximum_Tx_Window_Size in octets}$$

where utilized_window is the length in octets of the window bounded by VT(A) and VT(S).

9. The following relates to another embodiment for the protocol parameter Poll_Window.
10. This protocol parameter (from 3GPP RLC Spec.) indicates when the transmitter shall poll the Receiver in the case where “window-based polling” is configured by upper layers. A poll is triggered for each AMD PDU when:

$J \geq \text{Poll_Window}$, where J is the transmission window percentage defined as:

$$J = \frac{(4096 + \text{VT}(S) + 1 - \text{VT}(A)) \bmod 4096}{\text{VT}(WS)} * 100 ,$$

[page break to page 13]

where the constant 4096 is the modulus for AM described in subclause 9.4 (3GPP RLC Spec.) and VT(S) is the value of the variable before the AMD PDU is submitted to lower layer.

1. If flexible RLC PDU size is configured, a poll is also triggered for each AMD PDU when $K \geq \text{Poll_Window}$, where K is defined as:

$$K = \frac{\text{Sum of RLC PDU sizes from VT(A) to VT(S)}}{\text{Maximum Transmit Window Size}} * 100 .$$

2. With the protocol parameters Poll_PDU and Poll_SDU signaled by upper layers (RRC) to RLC as described above to indicate a interval "Poll_Bytes" in octets between polling:
 - The RLC Tx maintains a "Poll_Octets" counter of the total number of bytes transmitted in PDUs since the transmission of the last PDU containing a Polling bit.
 - When the "Poll_Octets" counter reaches the "Poll_Bytes" interval value, the RLC Tx sets the polling bit in the PDU that makes the "Poll_Octets" counter exceed the value (or optionally, the next PDU after). Then RLC Tx resets the "Poll_Octets" counter.

189. In 12/4, Apple relies heavily on the words "We also need ...", with the emphasis on *also* – Apple asserts that that means that on top of byte counting being taught, Every Poll_PDU PDU would actually and at the same time be used for its known purpose, to do with PDU counting. For what it is worth (it not being an issue for expert evidence what "also" means), Mr Boué-Lahorgue accepted that the sentence was ambiguous. In my view it just means that for and within the context of byte counting, suitable variables equivalent to those for PDU counting would be needed.
190. 12/5 clearly discloses a poll being triggered on the basis of byte-counting. That much was common ground.
191. However, the dispute between the parties on this paragraph was more subtle and turned on the count being of bytes transmitted in PDUs "*since the transmission of the last PDU containing a Polling bit*". The dispute takes the following shape.
192. As well as explicitly teaching byte counting, the section explicitly discloses the transmitter resetting the byte counter when a byte threshold (Poll_Bytes) is reached.
193. Apple contended that the paragraph also *implicitly* discloses resetting the byte counter when there was a PDU which contained a Polling bit *triggered by PDU counting*. If PDU counting were in operation at the same time as byte counting (which of course is disputed) and triggered a poll, then, Apple argued, the byte counter would go back to zero because it would have to start counting again from the PDU with the Polling bit triggered by PDU counting. And of course the PDU counter would be reset in the usual way. So there would be a "double reset".
194. The paragraph does not explicitly refer to PDU counting at all, but Apple's argument proceeded by stages: that the text meant the byte counter counted from the last PDU containing a polling bit triggered *for any reason*, and that one way a polling bit would be triggered would be from PDU counting.
195. The paragraph is not, in my view, clear. I think the more natural reading is that it is talking about the byte counting mechanism only, and referring to counting since that mechanism last triggered a poll. This would be fortified by the fact that the experts agreed that at the time, no poll trigger in UMTS was reset by any other

- poll trigger. So there is not teaching that the PDU counting poll would also reset the byte counter.
196. 12/8-10 and 13/1 disclose windows-based polling using J and K as transmission-window percentages expressed in terms of PDUs (J) and bytes (K), with the disclosure in 13/1 that a poll is triggered by J or K exceeding the poll window limit (see “ a poll is also triggered...” in 13/1).
197. As for 13/2, Apple relied on this as providing essentially the same teaching as 12/5; I agree that the paragraph does not improve or worsen Apple’s argument. Optis contended that the introductory two lines were a reference back (“as described above”) to page 5 and the concept of repurposing of existing parameters to derive Poll_Bytes. This is possible but not clear.
198. These are important passages for the disclosure of P3, but the essential battleground remains the same: is there a disclosure of a single method which has both byte and PDU counting and triggers a poll when either exceeds a limit?
199. Claims 4, 45 and 46 were referred to:
4. The method of claim 1, 2, or 3 further comprising enhancing RLC status reporting by a byte count.
 45. A method as in any preceding claim, wherein the current state variables used for fixed RLC PDU size are maintained and used simultaneously with a set of new variables that deal with the byte count of flexible RLC PDUs.
 46. The method of claim 45, further comprising maintaining one or more of the following values in terms of number of PDUs and processed as in the non-enhanced RLC:
 - The RLC transmitter state variables
 - VT(S), VT(A), VT(MS), VT(WS)
 - The RLC receiver state variables
 - VR(R), VR(H), VR(MR)
200. Claim 4 certainly teaches byte counting as an enhancement to existing RLC status reporting and although rather general would go to rebut any argument by Optis that PDU counting was not taught to be present in some way. But Optis does not argue this.
201. Claim 45 was relied on by Apple as dependent ultimately on claim 1. It has the advantage (for Apple) of stressing that new variables for byte counting with variable length PDUs are not only added but used at the same time as the variables previously used for PDU counting. But there is no explicit teaching of how to combine them, and what is said is fairly general. It might refer to setting window sizes, for example, and it might relate to the assessment involving the new value K, which is calculated by reference to the existing state variables VT(S) and VT(A).

Assessment

202. I have dealt with the disclosure of P3 by stepping through its contents in sequence. The parties organised their submissions thematically.

203. First, relevant to claim 1, is there a sufficiently clear disclosure of using byte counting and PDU counting together in the same method, so as to trigger a status report if either exceeds a predefined value?
204. In my view there is not. I agree that there is a clear disclosure of byte counting and triggering a status report by polling once a byte threshold is passed. And although perhaps not articulated explicitly, the reader would clearly understand that the PDU counting of UMTS was being preserved, with the associated parameters needed for it. But that does not mean that there is a disclosure of using them at the same time in one method as required by claim 1. I have considered each passage relied on by Apple with that in mind and am not persuaded by any of them. The attention to the parameters provided and/or needed is not helpful and tends to confuse, but in any case I accept Optis' case that certain of them were being repurposed for byte counting, and that does not necessarily imply the two counts being done at the same time in the way required.
205. Apple forcefully urged the point that it would not be sensible for the skilled addressee who saw that the window-based J (PDU) and K (byte) parameters were used together in the section on RLC Status Reporting not to envisage combining the equivalent counters. I think this is the wrong side of the line: it is an obviousness argument (quite possibly a very strong one) and Pani is a novelty-only citation.
206. Second, relevant to claim 9, is there a sufficiently clear disclosure of resetting both counters when the PDU counter threshold is passed? This turns on the interpretation of the passage on page 12 that I have dealt with above. I reject Apple's argument. Optis' reading is the better one, but in any event the passage is not clear.
207. The third issue, also relevant to claim 9, turned on the issue of construction of that claim that I have already covered. I have held in Optis' favour that the claim requires that there be a dual reset if either threshold is passed, and both must be assessed. Apple does not contend that the feature is met on this conclusion, since there is no disclosure of resetting the PDU counter if a byte threshold is passed.
208. The fourth issue is whether use in LTE (the subject of the proposed amended claims) is disclosed. This is only relevant if Apple's earlier arguments succeed, so it does not arise on my conclusions so far. Had it been relevant, I would have held that the disclosure of P3 is to the effect that its methods can be used in any development of UMTS which brought in variable length PDUs, including LTE. In my view this is the natural reading of the document as a whole. Optis' individual points are too pedantic. For example, the reliance on the language in 4/6 ("Node-B") is unrelated to what the technical teaching is.
209. The fifth issue is over the features of claims 4 to 6 (incrementing, setting and resetting to zero) which were formally still live but not separately defended by Optis. I agree with Apple that these features would be implicitly disclosed in P3 in the event that the features of claim 1 were to be present, in particular since the teaching on page 12 relates to counting up and then starting again (necessarily at zero) from the last PDU with a poll bit set. But claim 1 is not satisfied, for the reasons given above.

Allowability of the amendments

210. Since there is no need for Optis to amend, and since I have said that in that event narrowing to LTE would not help, I will deal with this very briefly. LTE is taught explicitly in the application as filed. I do not believe a skilled addressee would have any problem working out if a particular system was LTE or not and no evidence was put forward to suggest that they would. The real point taken by Apple was that the feature in product claim 12 (“adapted for use in LTE” in the product claim) lacked direct textual basis in the application. The point is insubstantial. “Adapted for...” means suitable for and the claim is just the product analogue of claim 1.
211. Therefore, the amendments are allowable in form. But had they been necessary to save the Patent over Pani/P3 I would have refused them because they would not provide novelty.

InterDigital

212. InterDigital is a TDoc submitted in May 2007 at a 3GPP RAN WG2 meeting. It is a proposal in the context of UMTS to enhance the existing window-based mechanism for PDU-based polling so as to deal with variable length PDUs.
213. It explains the thinking behind this in section 2:

“RLC Window Configuration

The existing window-based polling mechanism is based on sequence numbers. When flexible RLC PDU size is configured, large RLC PDU sizes will be transmitted and the RLC receiver window memory will fill up well before the current criterion for window-based polling is met if a typical value is used for the Poll_Window parameter (e.g 90%). This will result in transmission stalling.

To alleviate this issue one could configure the Poll_Window parameter with a much smaller **value**, such as 20%, to ensure that polling is always triggered before the memory is exhausted. However, this is not a viable solution as it would result in premature polling when smaller RLC PDU sizes are transmitted.”

214. This would be clear and easy to understand for the skilled addressee.
215. What is proposed is set out in section 3, whose introductory paragraph is as follows:

“Proposed Solution

The problem described in the above can be addressed by introducing a simple extension to the existing window-based polling mechanism as shown below. This consists of an additional criterion based on the percentage of the occupied window memory.”

216. Then the document sets out the existing, CGK, UMTS window-based mechanism:

“d) Poll_Window:

This protocol parameter indicates when the transmitter shall poll the Receiver in the case where "window-based polling" is configured by upper layers. A poll is triggered for each AMD PDU when $J \geq \text{Poll_Window}$, where J is the transmission window percentage defined as:

$$J = \frac{(4096 + \text{VT}(S) + 1 - \text{VT}(A)) \bmod 4096}{\text{VT}(WS)} * 100 ,$$

where the constant 4096 is the modulus for AM described in subclause 9.4 and VT(S) is the value of the variable before the AMD PDU is submitted to lower layer.”

217. I will return to the mathematics of this formula below, but essentially it works out the percentage occupancy of the window (J) and triggers a poll when that reaches or exceeds the limit defined by Poll_Window.

218. The enhancement (“simple extension”) proposed is then set out (I omit the track change and highlight from the original):

“If flexible RLC PDU size is configured, a poll is also triggered for each AMD PDU when $K \geq \text{Poll_Window}$, where K is defined as:

$$K = \frac{\text{Sum of RLC PDU sizes from VT}(A) \text{ to VT}(S)}{\text{Maximum Transmit Window Size}} * 100 . , ,$$

219. This only comes into play when flexible PDU size is used; when it is used, a poll is also (i.e. in addition to the J trigger) triggered when the window occupancy as a percentage calculated by reference to bytes (total bytes in the window divided by maximum allowed bytes in the window), denoted by K, reaches or exceeds Poll_Window. K is not given as a formal, precise formula in the way that J is; it is more descriptive. The skilled addressee would have to create some logic to track the sum of PDU sizes, but there was no suggestion that that could not be done.

220. I next need to go into the J calculation in more detail. Some points worth mentioning and/or repeating at this stage are:

- i) VT(S), VT(A) and VT(WS) are explained in the agreed CGK above. Simplifying slightly they represent the upper edge of the window, the lower edge of the window and the current permitted size of the window.
- ii) At the start of transmission VT(S) and VT(A) are both zero.
- iii) VT(WS) can be changed by higher layers or at the request of the receiver. There was a modest dispute about how often a change at the request of the

receiver would happen, but I accept Mr Kubota's evidence that it would be reasonably often.

- iv) As is also explained above in relation to the CGK, the 4096 and the mod 4096 are both there to cater for the fact that the PDU sequence numbers in UMTS wrap around once they reach 4095.
 - v) The +1 is there so that the equation relates to the next PDU to be sent.
221. For reasons I have already touched on in relation to construction of "counting", and on the basis of my conclusions there, the assessment of J with each PDU sent is not "counting" and does not involve counting:
- i) The equation gives a percentage, not a number of PDUs.
 - ii) VT(S) is not a counter. It is a state variable denoting the number of the next PDU to be sent and is included in the PDU to identify it. It will generally increment with each PDU sent (except when it wraps round) but that does not make it a counter.
 - iii) Likewise, VT(A) is not a counter. It does not even increment with PDU transmission but changes when PDUs are ACK'd.
 - iv) Nor is VT(S)-VT(A) a counter of PDUs transmitted. It is the occupancy of the buffer.
 - v) The use of the modulo arithmetic emphasises that VT(S) is not a counter since it drops back to zero when it exceeds 4095.
222. Mathematically, it is possible to rearrange this equation to give a value for VT(S)-VT(A) in terms of J and VT(WS). Mr Boué-Lahorgue gave the rearranged equation as follows in paragraph 239 of his first report:
- "A poll will be triggered when the count of transmitted data units (VT(S)-VT(A)) exceeds ((Poll_Window x VT(WS)/100-1)".
223. This refers to Poll_Window instead of J, since in the teaching of InterDigital an equation for J is given and the text explains that a poll is triggered when J is greater than or equal to Poll_Window.
224. But the fact that this rearrangement is possible does not change the points made above. Nor, when it comes to anticipation, is there a teaching to derive VT(S)-VT(A) in any event.
225. The fact that there is a third variable in the equation for J (VT(WS)) also emphasises that what is happening is not counting PDUs but assessing window occupancy on an ever-changing basis. Mr Boué-Lahorgue sought to finesse this by saying that VT(WS) was fixed by upper layers. He acknowledged but did not deal with the fact that it can be changed by the receiver and so is not fixed.
226. Apple's case was inconsistent and unclear as to whether it alleged that it was VT(S) or VT(S)-VT(A) or both that was a counter. I think this was because

neither was satisfactory for the conclusion necessary for Apple to succeed: VT(S) had the advantage that it incremented on transmission but the drawback that it was a number from 0 to 4095 not a counter of PDUs sent since the last reset or any other particular event, and does not reset to zero (at least in the sense I have held). VT(S)-VT(A), for reasons I will come onto, could sometimes increment steadily a bit like a counter upon transmission, but at other times would behave differently (depending on status reports). It also would drop to zero in certain circumstances.

227. In any event, I hold that neither is a counter, and nor was the process undertaken “counting”.
228. The same logic applies to the K equation for bytes.
229. Apple alleges that InterDigital anticipates claim 1 in all circumstances on the basis that there is always counting. I have rejected that because the claims do not cover windows-based mechanisms since they are not “counting” and because (a very closely related point) the windows-based implementation in Interdigital does not involve “counting”.
230. Apple alleges anticipation of claims 6 and 9 by InterDigital in a more complex way and on the basis that there is anticipation only in some circumstances. Apple says that claims 6 and 9 are anticipated where:
 - i) All PDUs are ACK’d; and either
 - ii) If no further PDUs are sent between a poll request and a status report then there is a true (my word) counter reset to zero; or
 - iii) If further PDUs are sent between a poll request and a status report then although there is no counter reset to zero, the counter is reset to a value such “as if” (Apple’s words) there had been a reset when the poll request was sent.
231. I am all too conscious that this is not easy to understand as written. In my defence it is essentially as written by Apple, with a little expansion and amplification. It is my intention that it will make more sense with some examples.
232. I will use as examples some of the drawings included by Mr Boué-Lahorgue in his reports. They are rather complex, and they could have been even more complex but for some simplification that he applied. The parties produced many, much more complex drawings for the cross-examination of both experts. I found them useful and I have taken them into account (Optis’ diagrams made a very good job of showing how different window and counter mechanisms are in terms of polling, and of tracking bytes and PDUs in circumstances of increasing but realistic complexity, by charting J and VT(PDU) against each other graphically over time), but setting them out and explaining them all in this judgment would be very burdensome, and probably not, in the end, very comprehensible.
233. Before I get into showing the examples, I will say that I think they are ultimately beside the point because the method of InterDigital is always the same. What the

examples show is that its output is, in certain circumstances, the same as, or very similar to a counting method. But that is not legally the question.

234. I start with a section from Apple’s opening skeleton which includes one of Mr Boué-Lahorgue’s figures, with some explanation that uses the abbreviations “MBL1” and “MBL2” for Mr Boué-Lahorgue’s reports (of course, Apple’s skeleton is not evidence whereas Mr Boué-Lahorgue’s report is):

116. MBL1 para 124 at page 37 explains the operation using this diagram.

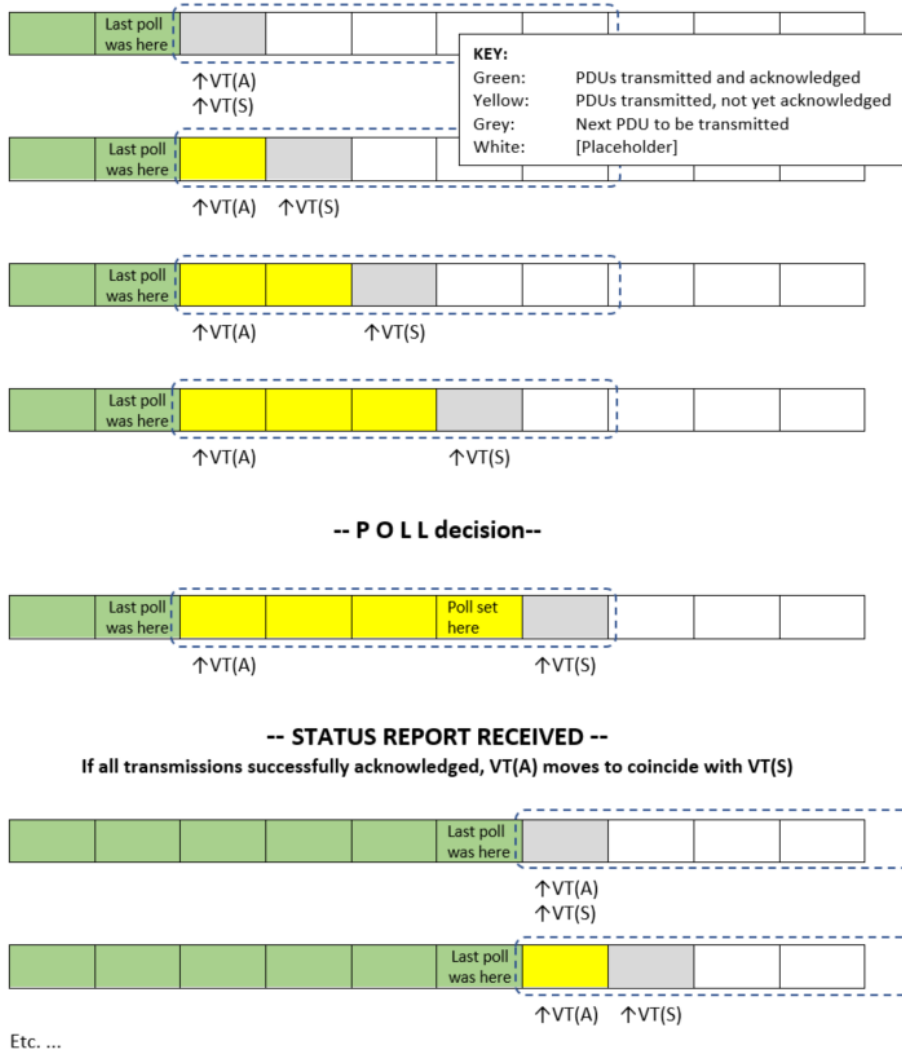

117. In the above example, for the top row $J = 20\%$ (0 unacknowledged PDUs, 1 grey PDU to be transmitted, window size 5, therefore 20% window occupancy). The following rows represent $J = 40\%$, 60%, 80%. A poll is then triggered at 80%, and after the status report is received acknowledging all the yellow PDUs, J reverts to 20% again. The term $(VT(S)-VT(A))$ resets to zero.

235. This shows J smoothly increasing until a poll is triggered, and following the resulting status report $VT(S)-VT(A)$ would, if calculated, be zero. No PDUs are NACK’d and there are no PDUs transmitted between the poll request and the

status report. It was common ground that that is possible; I return below to how likely it is, although I do not think that quantifying it is necessary or even relevant.

236. Paragraphs 118 and 119 of Apple’s skeleton then included the following:

118. J therefore tracks window occupancy, and it does so by counting the transmitted PDUs which are being held in the sliding window. The term $(VT(S)-VT(A))$ in the formula for J functions as a counter of the PDUs in the transmission window, in which $VT(S)$ increments as each new PDU is sent. It could not work if it was not counting them out. See again the diagram above, and that at Mr Boué-Lahorgue2 para 65 (showing behaviour at startup):

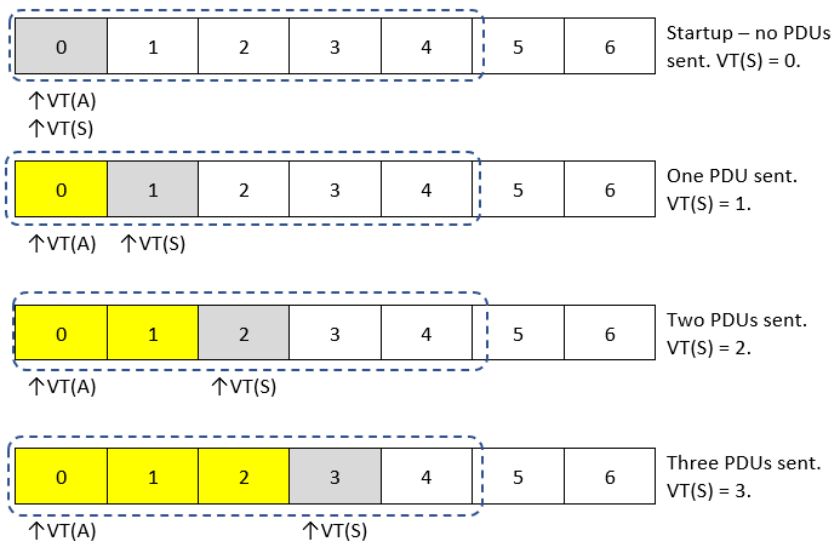

119. As MBL2 para 65 says of the above figure:

‘The variable $VT(S)$ which is incorporated in the expression for “J” used by the UMTS window-based mechanism is unquestionably a counter. It is initialised as zero and thereafter it is incremented each time a PDU is transmitted for the first time. It therefore counts all transmitted PDUs, as and when they are sent.’

237. This demonstrates the tension in Apple’s case to which I have referred earlier as to whether it is $VT(S)$ or $VT(S)-VT(A)$ that is the counter.

238. Apple and Mr Boué-Lahorgue both acknowledged that sometimes there would be PDUs sent between a polling request and a status report. Apple wrote at paragraph 120:

120. In the figure reproduced at para 116 above, the status report is shown as having been received before the next poll is transmitted. This will happen at least sometimes: see MBL1 para 244. MBL1 para 245 then describes the case where the transmitter may continue sending PDUs prior to receipt of a status report coming back from the receiver. This case is illustrated by the figure in MBL2 para 19 on page 9, which compares the way in which the

window-based polling trigger works with the Every Poll_PDU PDU counter-based polling trigger:

Window-based trigger

Counter-based trigger

Step 0: No PDU transmitted yet

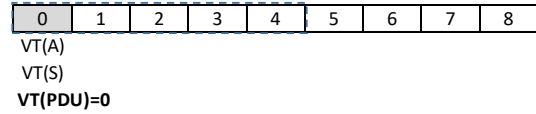
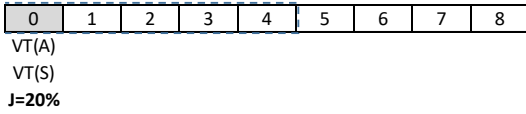

Step 1: PDU 0 transmitted

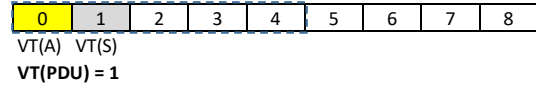
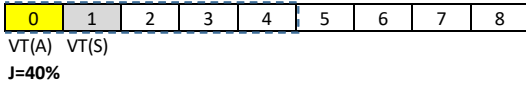

Step 2: PDU 1 transmitted

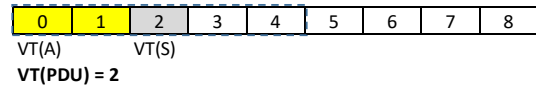
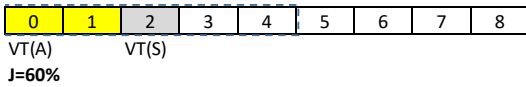

Step 3: PDU 2 transmitted

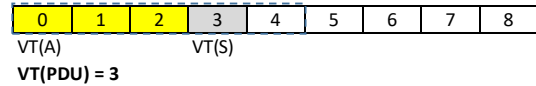
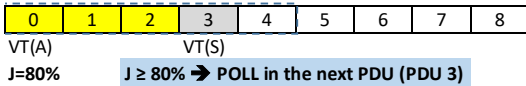

Step 4: PDU 3 transmitted

Poll transmitted

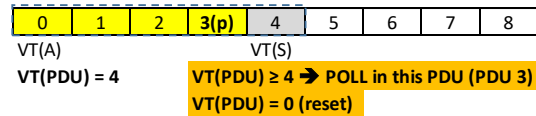
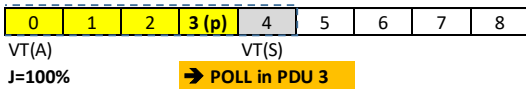

Step 5: PDU 4 transmitted

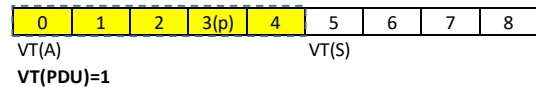
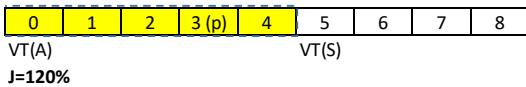

Step 6:

Status Report received

PDU 5 transmitted

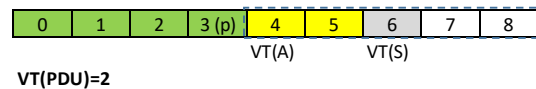
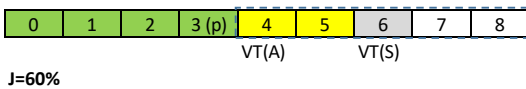

Step 7: PDU 6 transmitted

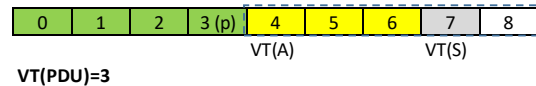
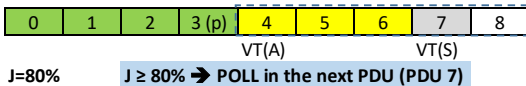

Step 8: PDU 7 transmitted

Poll transmitted

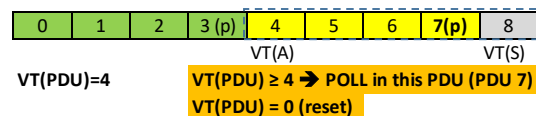

239. This figure, which shows the behaviour of a windows-based trigger on the left and counter-based on the right, is significantly simplified because unless something were done to stop it, the windows-based system would keep sending polling requests when J was 100% and 120%. The counter-based set-up inherently avoids this. So, as he accepted in cross-examination, Mr Boué-Lahorgue’s window-based column assumes that a poll prohibition is used. There was clearly no malice in this, but it must be borne in mind that the difference is not shown, and it is material: the Patent is all about polling, and the set-ups differ materially in relation to it.
240. Because of the “extra” PDU sent between poll and status report at step 5, VT(S)-VT(A) never resets to zero in the way that it did in the simpler, earlier case. By contrast VT(PDU) in the counter-based mechanism does reset to zero, at step 4. Apple’s point is that the two mechanisms are then back in step for the next poll, and it is “as if” VT(S)-VT(A) was reset at the earlier point.
241. If any PDUs are NACK’d in a status report then the counter-based mechanism will still have reset to zero once it reached the threshold, since it always does that. But the windows-based mechanism will not see VT(S)-VT(A) go to zero because they will be separated by at least the NACK’d PDUs lodged in the window, and nor will the “as if” reset happen, since, as Mr Boué-Lahorgue put it in paragraph 23 of his second report:

“23. In the case where a PDU in the transmission window has instead been NACKed, the two counts may become out of step since VT(A) cannot move forward as shown at Step 6 above. While the counter-based mechanism will then start counting from the PDU after the PDU that triggered the poll, the window-based mechanism would start further back, and count all PDUs from VT(A), the lower edge of the transmission window as shown below:

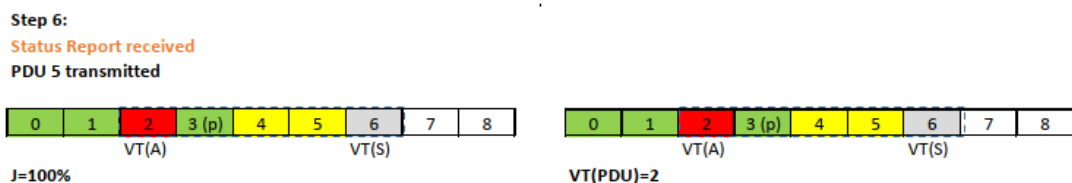

24. It can therefore be seen that while both mechanisms are intended to track sequence number use, the window-based method more accurately reflects the occupancy of the transmission window (and therefore the sequence numbers in use), whereas the PDU counter-based one sometimes gives an approximation. In practice, the threshold parameters for each of these triggers would be set with sufficient margins to allow for the retransmission of NACKed PDUs while avoiding stalling.”

242. This behaviour is why Apple does not allege anticipation of claims 6 and 9 except in circumstances where all PDUs are ACK’d.
243. While the skilled addressee would not think of these examples in particular, the matters that underlie them would be CGK, and they go to emphasise why windows-based mechanisms are different and do not just count transmitted PDUs.

It is because they look to actual window-occupancy instead of counting that they are more accurate than counting.

244. Two other points of detail, both minor but unfavourable to Apple, so tending to make its case worse if anything, are worth mentioning:
- i) There was an issue between the experts about whether a counter sets the poll bit in the next or current PDU when the threshold is met. In his second report Mr Boué-Lahorgue assumed that Mr Kubota was correct, which tended to bring the window and counter mechanisms more closely into alignment.
 - ii) Status reports or reports triggered by other polls will affect a windows based mechanism but not a counter based mechanism.
245. The other behaviour that is relevant is what Apple alleges to be the reset of claim 9. Apple alleges that this occurs when a polling request triggered either on the basis of J *or* K results, later, in a status report being received that contains all ACKs. In that situation, when the status report is received VT(S)-VT(A) will become zero; both the counter implicit in the J equation (on Apple's case) and the sum of the number of bytes in all the PDUs in the window (there will be none) will be zero.
246. In such a scenario, however, there will still be a chance for superfluous polling for reasons explained above in relation to construction of claim 9. That is why I construed claim 9 as requiring the reset immediately on the threshold being met. InterDigital does not do that. The reset relied on by Apple, even if it were such, and even if it were a reset to zero as required by claim 6, can only happen after the passage of time which could be enough to allow for superfluous polling. It can be no answer for Apple to try to limit itself to situations where there are no intervening PDUs, both for the reason given above that the method is always the same and because the transmitter does not "know" when it sends the poll request what will happen next in terms of ACKs or NACKs. What is certain is that resetting immediately avoids superfluous polling.
247. For all these reasons, claim 1 is not anticipated by InterDigital, and even if it were, claim 9 is not either.
248. In those circumstances, claim 6 does not in itself matter. It also only arises if I am wrong about claim 1 and therefore its consideration requires the assumption that the windows based mechanism is "counting". Since "counting" and "reset" rather go together in my reasoning, this requires some unusually difficult mental gymnastics. Briefly, I would hold that:
- i) VT(S)-VT(A) reflects window occupancy on a continually adjusted and consistently calculated basis. In certain circumstances it will go abruptly to zero, but it is not a reset as I have construed that term above. It is not a discrete step distinct from the ordinary "counting". It is perhaps loosely analogous to all the shoppers leaving at once.

- ii) I have held that it is not legitimate to look at the behaviour of the method in particular circumstances and that one must look at the method itself. But if I were wrong about that too, then Apple could focus on the no-intervening-PDUs case.
- iii) In the event of these multiple contingencies Apple would not need to rely on the “as if” case. But if it did I would reject the “as if” case as unreal. Any reset to a value other than zero could be characterised as being the same as a reset to zero at some earlier time.

InterDigital - Anticipation by equivalence

249. As I have said above, I gave permission to Apple to amend to argue that InterDigital anticipates by equivalence even if it does not anticipate on the ordinary meaning of the claims.

250. This requires the assumption that I am correct in how I have construed the claims. It then requires application of the three questions from *Actavis v. Lilly* [2017] UKSC 48 at [66]:

- i) Notwithstanding that it is not within the literal meaning of the relevant claim(s) of the patent, does the variant achieve substantially the same result in substantially the same way as the invention, ie the inventive concept revealed by the patent?
- ii) Would it be obvious to the person skilled in the art, reading the patent at the priority date, but knowing that the variant achieves substantially the same result as the invention, that it does so in substantially the same way as the invention?
- iii) Would such a reader of the patent have concluded that the patentee nonetheless intended that strict compliance with the literal meaning of the relevant claim(s) of the patent was an essential requirement of the invention?

251. I gave reasons for allowing the amendment on day 1 of the trial. I will not repeat them all, but some key points are worth reiterating:

- i) Birss LJ decided recently in *Facebook v. Voxer* [2021] EWHC 657 (Pat) that infringement by equivalence must be pleaded. I agree. It follows that anticipation by equivalence must be pleaded.
- ii) However, there will be cases en route to trial where the pleadings have closed before the parties knew that *Facebook v. Voxer* would be the regime. Allowance should be made for this.
- iii) There is a big difference between a fresh pleading of equivalence which raises for the first time a new and potentially disputed feature or behaviour of the alleged infringement, and one which seeks to characterise the matters already in issue as equivalent. The present case is very much the latter.

- iv) Where a pleading of equivalence is put in, it must identify the claim feature(s) to which it is directed and from there answer the *Actavis* questions by reference to each such feature. A general pleading that equivalence will be relied on wherever purposive construction fails is not good enough. I refused Apple's first draft of proposed amendments on that basis.
252. In addition to raising how equivalence should be pleaded, the present case raises the issue of whether, as a matter of law, equivalence is available to broaden a claim as the target for an anticipation attack, or only applied to infringement. This is an extremely important point for UK patent law. It seems certain to need the consideration of the Court of Appeal and very probably the Supreme Court. When it is first ruled on in a case where it is decisive to the result, it will need to be fully argued, including with reference to the law of other EPC jurisdictions and with regard to how and whether people can be prevented from practising the prior art, or if not, how and why not.
253. Apple's late pleading amendment did not leave time for this sort of detailed and demanding argument to be prepared. Therefore the parties agreed that I should take the approach of assuming that equivalence is not available (in line with the approach taken in other cases in the Patents Court), but to make such factual findings as are necessary, and answer the three questions.
254. Apple relied on equivalence in relation to claim features 1(d), 1(g), 6(b) and 9(b). In its closing submissions Optis addressed the points by reference to those features. Apple organised its submissions under the headings "counting" and "reset", but it came to the same thing.
255. There is no issue about how InterDigital works. There is also no question that the skilled addressee would fully understand how it works. I therefore have no finding of fact to make, and the second question has no role to play (as is usually the case given the way the Supreme Court expressed it, and as will probably always be the case with deterministic systems such as the present).
256. I turn to question 1 – does the alleged equivalent achieve substantially the same result in substantially the same way?
257. Apple relies on the "result" being tracking the same sets of resources, namely sequence number usage and buffer memory usage. Its submissions essentially treated this as the "way" as well. Apple's approach was based on, and arose from, evidence Mr Kubota had given on equivalence for the purpose of infringement/essentiality, where he referred to tracking those resources.
258. Optis disagreed. It pointed out that in addition to tracking those resources, Mr Kubota had referred to simplicity of implementation and (claim 9) avoidance of superfluous polling. It pointed out that InterDigital is more complex (as windows based mechanisms will always be) and does not avoid superfluous polling. I agree with those points, and I have already analysed why above.
259. This disagreement between the parties is reminiscent of the arguments that used to take place, when the *Improver* questions (*Improver v. Remington* [1990] FSR

- 181) were frequently applied, about the right level of generality to assess question 1. If the right level was simply that the alleged infringement worked then question 1 answered itself.
260. In the present case, I have no hesitation in reaching the conclusion that the right level of generality, and the result to be considered, is as Optis says, and Apple's argument is at the wrong level of generality. Simplicity and avoiding superfluous polling are both relevant "results" and they are achieved by the specific use of counting (as I have construed it) and immediate resets, while (although this is not necessary to my conclusion) omitting the use of status reports. It is justifiable to regard these as the "result" and as being at the right level of generality because they are flagged in the specification. So Apple fails on question 1, for all the disputed integers.
261. I have already said that question 2 has no role to play. I will go on to consider question 3 – whether there is anything in the specification to indicate that strict compliance was intended – very briefly in the event that I am wrong about question 1. Perhaps confident of its position on question 1, Optis said very little about this. Apple on the other hand asserted that it was common ground that there was nothing in the specification to intend strict compliance; this was too optimistic as I do not believe Optis made any such concession.
262. In relation to "resetting", and/or resetting to zero, I would agree with Apple on question 3, had it won on question 1. On the assumption that a delayed reset achieved the same result in the same way, there is nothing in the specification to help confine the claims.
263. However, on "counting" the position is very different. The equivalent sought to be captured is, essentially, a windows-based approach when the normal purposive construction would be limited to a counter-based approach. But the windows-based approach is specifically mentioned in the specification. If a specification lists A and B and then only claims (as a matter of language on normal interpretation) A, then that might well be an indication that strict compliance at least so as to exclude B was intended. I think it is clearly implicit in the judgment of Birss J in *Illumina v. Latvia* [2021] EWHC 57 (Pat) e.g. at [338] that this sort of argument is a legitimate one and may be a powerful one, although it did not arise on the facts before him.
264. For these reasons, the anticipation by equivalence argument would fail, even assuming it were available as a matter of law.

Obviousness over InterDigital

Legal principles

265. There was no dispute about the basic principles. I was referred to the decision of the Supreme Court in *Actavis v. ICOS* [2019] UKSC at [52] – [73], with its endorsement at [62] of the statement of Kitchin J as he then was in *Generics v. Lundbeck* [2007] EWHC 1040 (Pat) at [72].

266. Apple relied on *Brugger v. Medicaid* [1996] RPC 635 at 661, approved by the Supreme Court in *Actavis v. ICOS* to the effect that an obvious route is not made less obvious by the existence of other obvious routes. Apple relied on this (a) to seek to head off an argument that it perceived Optis would make that the only obvious thing to do over InterDigital would be exactly what it taught, and (b) to seek to minimise any importance of Mr Kubota's review of contemporary TDocs as a "Simpkins list" (see *Brugger*, *ibid.*). I accept the principles and will deal with its application in context.
267. Apple also relied on the same passage in *Brugger* for the closely related and well-known principle that what other workers did is not likely to be of assistance if they did not know about the pleaded prior art. Again, I accept this.
268. Apple advanced its case by the *Pozzoli* analysis. Optis did not arrange its submissions explicitly according to *Pozzoli*, although it did of course seek to identify the skilled addressee and the CGK.
269. Optis reminded me that I must avoid hindsight; I agree.

Pozzoli questions 1 and 2

270. I have addressed the skilled addressee and the CGK above.

Pozzoli question 3

271. Apple submitted that the only difference between InterDigital and claim 1 was (on the necessary assumption that it was wrong about "counting" so that there was no anticipation) using a counter-based approach instead of a window-based approach; InterDigital already had the idea of having regard to bytes as well as PDUs. I agree with this in general; that change would satisfy any difference in claim features and captures the inventive concept.
272. Although Optis did not formally work through *Pozzoli*, it did argue that simply adopting a "counter" would not satisfy the requirements for thresholds ("predefined values") or comparison of thresholds with counters. I found this rather hard to follow and I reject it. It seemed like an attempt to increase the number of differences for question 3 without regard to the substance. Deciding to use a counter (in the narrow sense) along the lines of the UMTS PDU counter-based trigger would automatically involve the use of a threshold and a comparison.
273. Optis accepted that if claim 1 was obvious over InterDigital, then so was claim 6.
274. As to claim 9, one again has to assume that the anticipation case fails, and furthermore the "reset" relied on by Apple for anticipation, of VT(S) - VT(A) automatically falling to zero on an all-ACK status report would not exist, assuming a switch to a counter-based method. On the construction of claim 1 that I have arrived at, the additional difference for claim 9 is resetting both PDU and byte counters to zero immediately upon either threshold being met.

Pozzoli question 4

275. The essential elements of Apple's case seemed to me to be as follows:

- i) InterDigital would seem useful to a skilled addressee working on LTE.
- ii) Such a skilled addressee would have in mind, because it was CGK, the Editor's note that either a counter or a windows-based approach was to be used.
- iii) The skilled addressee would see that InterDigital had opted for a windows-based approach, and that it addressed stalling from both a PDU number and memory perspective.
- iv) The skilled addressee would regard InterDigital as an attractive solution.
- v) The skilled addressee would regard counting and windows-based approaches as very similar, although with somewhat different pros and cons.
- vi) Whether to use a counter or a windows-based approach was really just a matter of taste and some in the art preferred counters.
- vii) It would therefore be uninventive to change InterDigital to a counter-based approach.
- viii) The points about attitudes to counter and window based approaches was supported by the TDoc review carried out by Mr Kubota.

276. Point i) was not in dispute; one particular reason for it is that InterDigital identifies in section 2 a problem with variable length PDUs which would be of direct relevance to LTE.

277. Optis accepted points ii) to iv) to a considerable extent but argued that their result would be that the obvious thing to do with InterDigital would be to implement it as written, with its windows-based approach. That, it said, was the most or even "only" obvious thing to do. It would be contrary to the principle explained in *Brugger* to which I have referred above to halt the analysis there in that way; even if the most obvious thing to do with InterDigital was to implement it as it stood, I must still ask what else was obvious (if anything), and whether the invention of claim 1 was.

278. Nonetheless, it is clearly a relevant factor that InterDigital had, as it were, taken the "windows" fork in the road presented by the Editor's note, and had worked it through to a solution. Apple's argument involves reversing back to the fork in the road and opting for and then implementing a counter-based solution.

279. Optis did not accept points v), vi), vii) or viii). It pointed to aspects of InterDigital which meant that the decision for a windows-based solution was one of real substance and complexity.

280. As to points v) and vi), it is worth clearing out of the way a dispute which I think was essentially a semantic one, about whether windows-based and counter-based approaches both “tracked” window occupancy. It is true that windows-based approaches involve actually following the contents of the window using status reports and counter-based approaches do not; they do not depend on status reports at all. To this extent the former “tracks” and the latter does not. However, as was clear and as Mr Kubota accepted, the latter is an approximation of the former; how close an approximation depends on conditions including in particular the number of NACKs.
281. As to point viii), Optis said that the upshot of Mr Kubota’s TDoc review was that there was an overall direction of travel in the art in favour of windows-based solutions.
282. In relation to the disputed points, each expert stood their ground. There was a genuine difference of opinion.
283. In my view, Apple’s case represents a considerable oversimplification of the real-world position. The notional skilled addressee would be aware of counter-based and window-based triggers, with their similarities and differences. That does not mean that there was a perception in the art that they were interchangeable, or that which to use was merely a matter of taste. Switching between them was not perceived as merely a workshop modification in the way that the choice of glue or nails might be when two physical items have to be fixed to each other.
284. In particular on this aspect of the obviousness case, I bear in mind that although e.g. UMTS contained provision for counter-based and window-based triggers, the problem being tackled by InterDigital concerns tracking two related things (sequence numbers and bytes) at the same time, with two linked poll triggers. This was not a situation with which the skilled addressee would be familiar.
285. InterDigital’s approach is “neat” (Mr Kubota’s word) partly because the use of the state variables VT(S) and VT(A) facilitates tracking of sequence numbers and bytes at the same time. There is no direct analogy in a counter-based system.
286. Just as Apple’s case was an oversimplification, I thought that Optis tried to make things unnecessarily complicated and to overstate the skilled addressee’s reaction to the idea of using a counter-based approach, or reasons why they would be disinclined to think of it at all. For example, Optis argued that switching to a counter-based approach would involve throwing away any use of status reports for polling decisions. So it would, but not using status reports for polling decisions is inherent to counter-based approaches and why they are approximations. Indeed, although I pressed Counsel for Optis on it, he was not able to identify anything which a switch to a counter-based approach would yield which was not inherent to counter-based approaches. There is no surprising result if the change were to be made. These are factors in Apple’s favour.
287. So far as Mr Kubota’s TDoc review is concerned, it is secondary evidence relating to obviousness and therefore must be kept firmly in its place. I do not have useful evidence of the detailed thinking behind the work, and I accept Counsel for Apple’s submission that it cannot have real value as a Simpkins list or as specific

evidence of non-obviousness given that the TDocs' authors did not have the Editor's note in mind and were not considering what to do faced with InterDigital, since there is no evidence that any of the authors saw it.

288. Apple sought to turn the review back on Optis by the argument that it showed that there were those who preferred counters, even if they might have been in the minority. I do not find this approach helpful or persuasive. The exercise cannot establish that there was a CGK view that windows and counters were interchangeable in all circumstances. The authors opted to advocate for counter-based solutions in specific circumstances, not as a generality.
289. Overall, I do not think this secondary evidence had any value in either direction.
290. These arguments are quite finely balanced and there are valid points both ways. However, overall I prefer Optis' position. In particular, there is nothing in InterDigital to suggest or motivate a change to a counter-based system, or, as it were, to revisit the choice presented by the Editor's note. Lack of motivation is not fatal to an obviousness case and indeed in a true workshop modification case there may be no motivation at all, yet the change is obvious in law. However, Apple has failed to make out that this is a workshop modification case.

Claim 9

291. By contrast, I think the situation on claim 9 is a clear one and I reject Apple's obviousness case.
292. Assuming that the skilled addressee started from InterDigital they would do so having appreciated that the way that it would deal with superfluous polling would have to be by the use of a poll prohibit timer. InterDigital spells out the superfluous polling problem in sections 2 and 4 but is not explicit about the solution. However, the evidence was that the only solution that would occur to the reader of InterDigital for use in what it proposed would be the poll prohibit timer. The fact that it was under discussion whether LTE would even have a poll prohibit timer would only add to the complexity and might, if anything, put the skilled addressee off InterDigital altogether.
293. On top of this, such dual "reset" as there might be said to be in windows-based systems, when VT(S) and VT(A) went back to zero at the same time following an all-ACK status report, would be done only on receipt of the status report and not immediately upon reaching the threshold.
294. Mr Boué-Lahorgue gave evidence that the skilled addressee would "know" that the counters could be reset in response to the receipt of a status report or in (immediate) response to the threshold being met. I thought this was purely conclusory and unsupported by adequate examples or reasoning.
295. What is more, there was no precedent in the field for polls resetting each other. InterDigital does it in a sense because of the common significance of VT(S) – VT(A) in a windows-based system, but that is not the same thing.

296. These factors would, in my view, lead the skilled addressee away from the idea of claim 9, starting from InterDigital. In all likelihood they would rely on the poll prohibit timer, and even if they thought about a dual reset they would do it on receipt of a status report.
297. So claim 9 is inventive over InterDigital even if claim 1 is not.

THE ESTOPPEL ISSUES

Outline

298. Apple says that even if the Patent is valid and infringed, there is a proprietary estoppel in its favour which prevents Optis from enforcing it, or restricts the relief that Optis can obtain.
299. The basic events, which are not in dispute, are as follows (I explain the process and the terms used in more detail below):
- i) On 8 January 2008, Ericsson filed a US Provisional Patent Application No. 61/019746 (“the Ericsson US Provisional”).
 - ii) The same day, Ericsson uploaded onto 3GPP’s FTP server a technical proposal, a “TDoc”, R2-080236 (“the Ericsson TDoc”). There was a related Change Request but it makes no difference to the argument.
 - iii) The Ericsson US Provisional and the Ericsson TDoc contained very much the same information as one another, and focused on the “single mechanism” to which I have referred in dealing with the patent issues. They included the pseudocode that appears in [0045] of the Patent.
 - iv) At two 3GPP RAN Working Group 2 (“RAN WG2”) meetings in 2008, Ericsson’s representatives successfully made a case for the inclusion of the disclosure of the Ericsson TDoc into the LTE standard, leading to its forming part of ETSI Technical Specification TS 36.322.
 - v) TS36.322 was frozen (the stage 3 freeze date) on 11 December 2008.
 - vi) Ericsson did not mention the existence of the Ericsson US Provisional at the RAN WG2 meetings and did not declare it to ETSI until 20 May 2010.
300. Apple’s case that this creates a proprietary estoppel takes two forms (this is a very brief summary of arguments that have many nuances):
- i) First, it makes what it calls its “*no-IPR*” case, which is that ETSI and/or members of RAN WG2 were under an assurance that Ericsson had no IPR over the Ericsson TDoc, as a result of which a chance was lost for them to seek an alternative, unpatented solution. I will refer to “IPR” and “IP” in this judgment generally, although in fact it is only patents and patent applications, not other forms of intellectual property, that are relevant.

- ii) Second, and as a fallback, it says that there was a “*loss of process*”, such that even if there was no likelihood of the assurance making any difference in terms of a non-patented solution being sought or found, ETSI’s rules and procedures were not followed, and that is enough.
301. Apple says that the relevant assurance arose either by Ericsson acquiescing in the belief of RAN WG2 members that there was no IPR covering the Ericsson TDoc, or by Ericsson having made an implicit assertion by silence that there was no such IPR.
302. Part of Apple’s case, which occupied a very large proportion of the time at trial, was that Ericsson’s omission to reveal the Ericsson US Provisional by declaring it to ETSI, prior to the standard being frozen, was a breach of Clause 4.1 of ETSI’s IPR Policy, which is subject to French law and has contractual force between Ericsson and ETSI. Clause 4.1 is as follows:
- “... each MEMBER shall use its reasonable endeavours, in particular during the development of a STANDARD or TECHNICAL SPECIFICATION where it participates, to inform ETSI of ESSENTIAL IPRs in a timely fashion. In particular, a MEMBER submitting a technical proposal for a STANDARD or TECHNICAL SPECIFICATION shall, on a bona fide basis, draw the attention of ETSI to any of that MEMBER’s IPR which might be ESSENTIAL if that proposal is adopted.”
303. Optis disputes breach of Clause 4.1. It says that declaration prior to the stage 3 freeze date was not required, and was rarely done in practice by anyone. However, it says that in the circumstances the RAN WG2 members would have assumed, if they thought about it, that the Ericsson TDoc was most probably covered by IPR regardless of whether Ericsson declared. It says that the Working Groups (“WGs”) did not and in practice could not consider the IPR status of TDocs. Overall it therefore says that Ericsson’s behaviour as to declaration was completely inconsequential.
304. Apple says its allegation of breach of Clause 4.1 is part of its case but not essential to it; that there was a relevant assurance in any event. Optis says that if there is no breach of Clause 4.1 then Apple must fail, but says that there was no relevant assurance in any event.
305. The parties also disagree over whether or not there existed a non-patented but equally good technical alternative to the Ericsson TDoc technology. If there was not, Optis says that is another reason why Ericsson’s behaviour was immaterial.
306. Most proprietary estoppel cases focus intently on the behaviour, motives and states of mind of the person asserting the estoppel and the person alleged to be estopped. In the present case, however, there is no fact witness from Apple or Ericsson.
307. Apple was not a member of the relevant working group at the time (although it was an ETSI member and a participant in other working groups). It is not alleged that it was aware of the events listed above or acted or refrained from acting in any particular way; its case however is that (1) a proprietary estoppel arose as a

result of the effect on those who were RAN WG2 members and/or ETSI itself (2) of which it, as an ETSI member and standards-implementer, was also the beneficiary. The argument before me proceeded in those two, separate, stages. I must say that I question if it was right to separate them in that way given the broad inquiry that proprietary estoppel requires in relation to the person claiming the estoppel, but I have followed the parties' course, and it does not make any difference given that I find, for many reasons, that on the facts there was no proprietary estoppel at all.

308. Optis is Ericsson's successor in title. There was a dispute about whether any estoppel that would have afflicted Ericsson has passed with the Patent to Optis.
309. Against this background, I have to consider the following matters, which I summarise in broad headings and not overlooking the very numerous sub-issues raised by the parties:
- i) The relevant law of proprietary estoppel.
 - ii) What is the relevant French law applicable to Clause 4.1.
 - iii) The general history and arrangement of ETSI and 3GPP. It is almost entirely uncontroversial.
 - iv) How WGs functioned. There were some disputed aspects of this but they reduced as the trial went on.
 - v) The operation of the ETSI declaration process. This was also disputed to a minor degree.
 - vi) The history of how (a) ETSI's rules and (b) its members' approach to declaring IP developed, and how they stood in 2008.
 - vii) What Clause 4.1 requires and whether there was a breach of it.
 - viii) Whether the elements of proprietary estoppel are made out and whether the no-IPR or loss of process arguments succeed.
310. Optis had a further argument, which it called the "clean hands" point, which was essentially to the effect that Apple also consistently declared well after the relevant freeze date. It argued that if Ericsson's behaviour was unconscionable then so was Apple's and that Apple could therefore not invoke the equitable doctrine of proprietary estoppel. Since I hold below that Ericsson did not behave unconscionably and that there was no proprietary estoppel anyway, I have not had to decide this point as such, and have confined myself to making factual findings about Apple's conduct.
311. If I concluded that there was a proprietary estoppel then I would have to consider:
- i) Whether Apple could benefit from it.
 - ii) Whether Optis was burdened with it.

iii) What was the appropriate remedy.

312. Since I have concluded that there was no proprietary estoppel and Apple fails on the facts on any legal analysis, I have addressed benefit, burden and remedy only to a very limited extent.

“Patent ambush”

313. “Patent ambush” is a concept relied on by Apple and referred to in some of the documents surrounding the history of the ETSI IPR Policy. I think it is important to appreciate that there are different circumstances to which it can be applied. They all relate to non-disclosure by a patentee of actual or potential patent rights during standards development, but the effects may be very different.

314. One form of patent ambush would be for a patentee not to reveal its patent rights until after the inventions in question have been taken into a standard, so that entities practising the standard have to use the invention, and then to refuse to license, or to license only at an extortionate rate. It is clear that ETSI is and always has been acutely alive to this risk, which it seeks to meet by requiring FRAND undertakings, and by provisions allowing it to change the standard if necessary (a last resort, for obvious reasons). Competition authorities including the European Commission (“the Commission”) also recognise the risk it poses. However, it is not what this case is really about, since Ericsson declared the Patent to ETSI and Optis accepts the existence of the resulting FRAND obligation, although it and Apple disagree about aspects of it, including in particular what a FRAND rate would be.

315. A second form of patent ambush would be for a patentee not to reveal its rights during the setting of a standard which is hoped to be entirely patent-free. Again, the Commission is well aware of it. For example, it issued a communication in 1992 titled “Intellectual Property Rights and Standardization” on which Apple relied, but without recognising the different context: telephony standards, including UMTS and LTE, have always been expected to involve patented technology. A standard with potential to be entirely non-proprietary (called JEDEC) was the context of the Commission inquiry into Rambus between 2002 and 2009, to which the parties referred in argument.

316. A third form of patent ambush would be for a patentee not to reveal its rights during the setting of a standard where it is expected that patented technology will be included. This is the kind of ambush potentially at play in the present case, although Optis says that the WG participants who chose the solutions for the standards always just did their best to choose the best technical solution, so patents did not matter. Apple says that it might be desirable, even in that situation, for the WGs to be able to choose patent-free solutions if they were equally good, to keep licensing costs down.

Case management

317. The parties’ evidence and arguments were diffuse and wide-ranging. I asked several times for a list of issues. It was apparent that tactical skirmishing was hindering its preparation, and I raised the matter more than once during the trial

and during oral closing arguments. The parties suggested more than once that there should be two list of issues, one from each side. I said no: that would not provide me with identification of what I needed to decide, or a usable checklist.

318. Eventually, I was provided with an “Agreed List of the Main Issues”. It contained 217 “main” issues over 22 pages. Many of the issues had multiple sub-issues. Many were expressed with a top-level issue followed by a contentious elaboration from each side. Some were extremely general and not at all useful, such as “24. How successful have ETSI and 3GPP been?”.
319. I have endeavoured to use the list at least to ensure that I have dealt with the disputed points that matter, but it has not served even that limited function at all well. The parties should have done much better, much sooner. Their representatives have obligations to the Court as well as to them, to help efficient management of the dispute. Neither side has been helped by trying to pack the list of issues with its own arguments, in any event.
320. I return to this theme in relation to French law, where at least in the end a usable summary was provided.

THE LAW OF PROPRIETARY ESTOPPEL

Basic elements of the doctrine

321. The parties essentially agreed about the basic elements of proprietary estoppel. They referred in particular to *Yeoman’s Row Management Limited & Ors v. Cobbe* [2008] UKHL 55, *Thorner v. Major* [2009] UKHL 18, and *Mohammed v. Gomez* [2019] UKPC 46. They also referred to *Gillett v Holt* [2001] Ch 210, and I will need to return to that case below on one particular point.
322. For the basic elements of the doctrine, I need only refer to *Thorner v. Major* and, to a lesser degree, *Yeoman’s Row v. Cobbe* and *Mohammed v. Gomez*.

The three elements

323. In *Thorner v Major*, David Thorner brought a claim against the estate of his father’s cousin, Peter Thorner. Peter Thorner had owned a farm, with which David Thorner helped him, for no remuneration, until his death 29 years later. David Thorner did so because he believed that he would be Peter Thorner’s successor upon his death. Peter Thorner made a number of remarks to David Thorner that encouraged his expectation in this regard, although none of these remarks were express. David Thorner had failed to pursue a number of other (more profitable) opportunities during this time. When Peter Thorner died, he left no will. David Thorner brought a claim against Peter Thorner’s estate, claiming that it was estopped from denying that he had acquired the beneficial interest in the farm.
324. The judge at first instance found that David Thorner did have the benefit of a proprietary estoppel, as he had reasonably understood Peter Thorner’s remarks to be an assurance (and had relied on them to his detriment), and Peter Thorner

intended them to be understood in this manner. The Court of Appeal overturned the decision, on the basis that the judge had not found that the assurance was intended to be relied upon and there was no evidence of Peter Thorner's intention. The issue before the House of Lords was therefore the character and quality of the assurances made to the claimant, and the adequacy of those assurances.

325. In considering the claim, Lord Walker identified the three main elements required for a claim based on proprietary estoppel:

"29. [...] Nevertheless most scholars agree that the doctrine is based on three main elements, although they express them in slightly different terms: a representation or assurance made to the claimant; reliance on it by the claimant; and detriment to the claimant in consequence of his (reasonable) reliance".

326. Thus the three basic elements are:

- i) Assurance;
- ii) Reliance;
- iii) Detriment in consequence of the reliance.

327. Lord Scott noted (taking the same view as Lord Walker):

"15. [...] These elements would, I think, always be necessary but might, in a particular case, not be sufficient. Thus, for example, the representation or assurance would need to have been sufficiently clear and unequivocal; the reliance by the claimant would need to have been reasonable in all the circumstances; and the detriment would need to have been sufficiently substantial to justify the intervention of equity."

328. Lord Walker also considered the issue of whether an assurance needed to be "clear and unequivocal", and said (at [56]) that he

"would prefer to say (while conscious that it is a thoroughly question-begging formulation) that to establish a proprietary estoppel the relevant assurance must be clear enough".

329. When considering the issue of reliance on a representation, Lord Scott held that the assessment of the representor's intentions (and whether he intended those representations to be relied upon) must be an objective assessment:

"17. [...] If it is reasonable for a representee to whom representations have been made to take the representations at their face value and rely on them, it would not in general be open to the representor to say that he or she had not intended the representee to rely on them. This must, in my opinion, particularly be so if, as here, the representations are repeated or confirmed by conduct and remarks over a considerable period."

330. The House of Lords held that on the basis of the factual findings of the first instance judge, these elements of a proprietary estoppel had been satisfied.

Objectively assessed, Peter Thorner’s assurances were intended to be relied on, and there was not sufficient reason for the Court of Appeal to reverse the trial judge’s finding.

The role of unconscionability, not a “joker”

331. Unconscionability on the part of the person alleged to be estopped is important to the doctrine. Its role was explained by Lord Walker in *Yeoman’s Row v. Cobbe*:

“92. Mr Dowding devoted a separate section of his printed case to arguing that even if the elements for an estoppel were in other respects present, it would not in any event be unconscionable for Mrs Lisle-Mainwaring to insist on her legal rights. That argument raises the question whether “unconscionability” is a separate element in making out a case of estoppel, or whether to regard it as a separate element would be what Professor Peter Birks once called “a fifth wheel on the coach” (*Birks & Pretto (eds) Breach of Trust* (2002) p.226). But Birks was there criticising the use of “unconscionable” to describe a state of mind (*Bank of Credit & Commerce International (Overseas) Ltd v Akindele* [2001] Ch 437, 455). Here it is being used (as in my opinion it should always be used) as an objective value judgment on behaviour (regardless of the state of mind of the individual in question). As such it does in my opinion play a very important part in the doctrine of equitable estoppel, in unifying and confirming, as it were, the other elements. If the other elements appear to be present but the result does not shock the conscience of the court, the analysis needs to be looked at again.”

332. Counsel for Apple pointed out that there are few if any cases where the three basic elements of assurance, reliance and detriment have been made out, yet proprietary estoppel has failed because of a distinct finding that unconscionability is not present. This is true, but in my view not surprising. Lord Walker’s formulation makes clear that unconscionability is a cross-check which may lead the Court to revisit its analysis on the three main elements. If an allegation of proprietary estoppel fails when such cross-check is made, the failure is likely to be expressed in terms of the absence of one or more of the basic elements.

333. In my view the passage above makes clear that the standard of unconscionability is an objective one. Apple accepted this, but argued that the state of mind of the party alleged to be estopped was a material factor. I did not understand the submission, but in any event it does not matter because I have not received evidence about Ericsson’s state of mind and any inference I could possibly draw about it would be based on the objective facts.

334. The parties agreed that unconscionability has a role in proprietary estoppel in addition to the three main elements, but does not found an estoppel on its own. Thus in *Yeoman’s Row v. Cobbe*, Lord Scott said this:

“16. [...] My Lords, unconscionability of conduct may well lead to a remedy but, in my opinion, proprietary estoppel cannot be the route to it unless the ingredients for a proprietary estoppel are present. These ingredients should include, in principle, a proprietary claim made by a

claimant and an answer to that claim based on some fact, or some point of mixed fact and law, that the person against whom the claim is made can be estopped from asserting. To treat a “proprietary estoppel equity” as requiring neither a proprietary claim by the claimant nor an estoppel against the defendant but simply unconscionable behaviour is, in my respectful opinion, a recipe for confusion.”

335. And to like effect, Lord Walker said:

“46. Equitable estoppel is a flexible doctrine which the Court can use, in appropriate circumstances, to prevent injustice caused by the vagaries and inconstancy of human nature. But it is not a sort of joker or wild card to be used whenever the Court disapproves of the conduct of a litigant who seems to have the law on his side. Flexible though it is, the doctrine must be formulated and applied in a disciplined and principled way. Certainty is important in property transactions. As Deane J said in the High Court of Australia in *Muschinski v. Dodds* (1985) 160 CLR 583, 615–616,

‘Under the law of [Australia]—as, I venture to think, under the present law of England—proprietary rights fall to be governed by principles of law and not by some mix of judicial discretion, subjective views about which party ‘ought to win’ and ‘the formless void of individual moral opinion’ [references omitted].”

No watertight compartments

336. It has been stressed by the Courts on a number of occasions that the individual elements of proprietary estoppel cannot be assessed in isolation. For example, in *Gillett v. Holt*, Walker LJ (as he then was) said at 225:

“This judgment considers the relevant principles of law, and the judge's application of them to the facts which he found, in much the same order as the appellant's notice of appeal and skeleton argument. But although the judgment is, for convenience, divided into several sections with headings which give a rough indication of the subject matter, it is important to note at the outset that the doctrine of proprietary estoppel cannot be treated as subdivided into three or four watertight compartments. Both sides are agreed on that, and in the course of the oral argument in this court it repeatedly became apparent that the quality of the relevant assurances may influence the issue of reliance, that reliance and detriment are often intertwined, and that whether there is a distinct need for a "mutual understanding" may depend on how the other elements are formulated and understood. Moreover the fundamental principle that equity is concerned to prevent unconscionable conduct permeates all the elements of the doctrine. In the end the court must look at the matter in the round.”

337. I did not understand this to be in dispute.

No categorisation

338. There have been attempts over the years to organize proprietary estoppel into different categories (acquiescence-, assurance- or promise-based in particular). In *Mohammed v. Gomez*, the Privy Council considered these analyses. Lord Carnwath reviewed the comments of Lord Walker in *Thorne v. Major* [2009] UKHL 18 (in particular those at paragraph 29, quoted above), before commenting:

“26. In the light of that discussion, the Board doubts how far it is possible or useful in the context of proprietary estoppel to draw fine distinctions between different categories. It is true that such issues seem to have attracted lively academic debate (see e.g. the references in *Snell's Equity* 33rd ed (2014), para 12-033). However, as Lord Walker makes clear, once one has moved beyond claims based on specific contractual rights, there may be no clear division between the nature and quality of any alleged verbal assurances, and the conduct of the respective parties in response. Depending on the factual context acquiescence may be seen as one aspect of assurance.

27. To similar effect is his earlier judgment in *Jennings v Rice* where he underlined the dangers of "over-simplification":

‘The need to search for the right principles cannot be avoided. But it is unlikely to be a short or simple search, because (as appears from both the English and the Australian authorities) proprietary estoppel can apply in a wide variety of factual situations, and any summary formula is likely to prove to be an over-simplification. The cases show a wide range of variation in both of the main elements, that is the quality of the assurances which give rise to the claimant's expectations and the extent of the claimant's detrimental reliance on the assurances. The doctrine applies only if these elements, in combination, make it unconscionable for the person giving the assurances (whom I will call the benefactor, although that may not always be an appropriate label) to go back on them.’ (para 44)”

339. As to what I have said thus far, apart from the point about whether unconscionability is to be assessed objectively or subjectively, the parties were agreed. I turn to matters where there was a disagreement about the law of proprietary estoppel.

Inaction or silence

340. Optis contended that mere inaction or silence cannot give rise to an estoppel. It referred to what Lord Wilberforce said in *Moorgate Mercantile Co Ltd. v. Twitchings* [1977] AC 890 at 903:

“... He is not estopped from asserting his title by mere inaction or silence, because inaction or silence, by contrast with positive conduct or statement, is colourless: it cannot influence a person to act to his detriment unless it acquires a positive content such that that person is entitled to rely on it. In

order that silence or inaction may acquire a positive content it is usually said that there must be a duty to speak or to act in a particular way, owed to the person prejudiced, or to the public or to a class of the public of which he in the event turns out to be one.”

341. Optis sought to rely on this to argue that the only positive duty on Ericsson can have been under Clause 4.1, so that if Apple failed on that argument, it must fail altogether. However, Lord Wilberforce went on to explain what he meant by “duty”:

“The necessity for this duty, particularly with regard to silence or omission, has been stated in many authoritative judgments too well known to need complete citation, for they were comprehensively reviewed by Lord Wright in *Mercantile Bank of India Ltd. v. Central Bank of India Ltd.* [1938] A.C. 287. Lord Wright says there, at p. 304:

‘the existence of a duty is essential, and this is peculiarly so in the case of an omission. . . . The duty may be, in the words of Blackburn J. [in *Swan v. North British Australasian Co. Ltd.*, 2 H. & C. 175, 182] ‘to the general public of whom the person is one.’ There is a breach of the duty if the person estopped [which I take to mean “sought to be estopped”] has not used due precautions to avert the risk.’”

My Lords, I think that the test of duty is one which can safely be applied so long as it is understood what we mean. I have no wish to denigrate a word which, to modern lawyers, has become so talismanic, so much a universal solvent of all problems, as the word “duty,” but I think that there is a danger in some contexts, of which this may be one, of bringing in with it some of the accretions which it has gained—proximity, propinquity, foreseeability—which may be useful, or at least unavoidable in other contexts. What I think we are looking for here is an answer to the question whether, having regard to the situation in which the relevant transaction occurred, as known to both parties, a reasonable man, in the position of the “acquirer” of the property, would expect the “owner” acting honestly and responsibly, if he claimed any title in the property, to take steps to make that claim known to, and discoverable by, the “acquirer” and whether, in the face of an omission to do so, the “acquirer” could reasonably assume that no such title was claimed.”

342. This makes clear, to my mind, that so far as a “duty” is required, it can be supplied by the person alleged to be estopped standing by when he or she is aware that the other party is under a misapprehension (the classic *Ramsden v. Dyson* situation (1866) LR 1 HL 129 at 140-141). It does not support Optis’ argument that there has to be a separate legal duty. Thus in theory I consider that Apple could succeed even if Optis was not in breach of Clause 4.1, but Clause 4.1 and its perception would still be important on the facts: if there was an understanding that declarations were not required before the freeze date under the rules, or that Clause 4.1 was not clear but declarations were often after the freeze date then ETSI and its members might be much less likely to infer from the lack of a declaration that there was no IPR.

Detriment

343. The parties agreed that detriment must be pleaded and proved and must be substantial. They also agreed that it must be assessed at the time when the assurance is resiled from. On the facts of the present case it might be said that it was resiled from (if at all) either when Ericsson did make its declaration to ETSI in 2010, or when Optis sought to enforce the patents the subject of this action (including the Patent) against Apple. I prefer the former view, since at that point Ericsson made clear that it had rights that it was prepared to exercise, albeit subject to a FRAND commitment. I doubt if it matters, though.
344. Where the parties disagreed was in relation to the circumstances in which a lost opportunity might amount to a sufficiently substantial detriment; they agreed that it could “in an appropriate case”, but the focus of the disagreement was over what level of likelihood was required.
345. At its height, Apple’s case seemed to be that *any* degree of likelihood that an opportunity would have been valuable would be enough, on the basis that decisions on proprietary estoppel have deprecated conjecturing about what the person alleging the estoppel would have done, in the absence of the relevant assurance.
346. In *Gillett v. Holt*, the claimant spent his life working on the defendant’s farm. The defendant made a number of promises and assurances that the claimant and his wife would inherit the farm upon his death. When the relationships between the parties soured, and Mr Holt created a new will without provision for the Gilletts, Mr Gillett sought equitable relief. In relation to detriment, Walker LJ said (at 232):

“The overwhelming weight of authority shows that detriment is required. But the authorities also show that it is not a narrow or technical concept. The detriment need not consist of the expenditure of money or other quantifiable financial detriment, so long as it is something substantial. The requirement must be approached as part of a broad inquiry as to whether repudiation of an assurance is or is not unconscionable in all the circumstances.

There are some helpful observations about the requirement for detriment in the judgment of Slade LJ in *Jones v Watkins* 26 November 1987. There must be sufficient causal link between the assurance relied on and the detriment asserted. The issue of detriment must be judged at the moment when the person who has given the assurance seeks to go back on it. Whether the detriment is sufficiently substantial is to be tested by whether it would be unjust or inequitable to allow the assurance to be disregarded—that is, again, the essential test of unconscionability. The detriment alleged must be pleaded and proved.”

347. After considering further authorities on the issue of detriment, Walker LJ considered whether the Gilletts had suffered a detriment. He held that they had, and among the detriments they had suffered was the loss of an opportunity to “*better themselves*”. At 234-235, he said:

“It is entirely a matter of conjecture what the future might have held for the Gilletts if in 1975 Mr Holt had (instead of what he actually said) told the Gilletts frankly that his present intention was to make a will in their favour, but that he was not bound by that and that they should not count their chickens before they were hatched. Had they decided to move on, they might have done no better. They might, as Mr Martin urged on us, have found themselves working for a less generous employer. The fact is that they relied on Mr Holt's assurance, because they thought he was a man of his word, and so they deprived themselves of the opportunity of trying to better themselves in other ways. Although the judge's view, after seeing and hearing Mr and Mrs Gillett, was that detriment was not established, I find myself driven to the conclusion that it was amply established. I think that the judge must have taken too narrowly financial a view of the requirement for detriment, as his reference [1998] 3 All ER 917, 936 to "the balance of advantage and disadvantage" suggests. Mr Gillett and his wife devoted the best years of their lives to working for Mr Holt and his company, showing loyalty and devotion to his business interests, his social life and his personal wishes, on the strength of clear and repeated assurances of testamentary benefits”.

348. This is a long way from supporting Apple's position. It was a case where the parties who had received the assurance had quite clearly shaped their lives around it. All that Lord Walker was saying was that it was not possible to have any certainty about what would have happened if they had not received it.
349. Apple also relied on *Habberfield v. Habberfield* [2019] EWCA Civ 890, where a daughter worked on her parents' farm for thirty years. The father assured his daughter (subject to certain qualifications, which for the purposes of this judgment are not relevant) that when he could no longer manage the business, it would be passed to her. As a result of those assurances, Ms Habberfield did not consider setting up a farming business elsewhere, even when a nearby farm became available for rent. In considering whether the judge had erred in failing to give credit for the benefits Ms Habberfield had received while working on the farm, Lewison LJ said:

“47. There are two reasons why I do not consider that this demonstrates any error on the judge's part. First, the exercise upon which he was embarked was a broad judgmental discretion. Second, his finding was that only part of the detriment was quantifiable. The main detriment that Lucy suffered was that she had “positioned her working life” on Frank and Jane's assurances. That detriment was incapable of reduction to pounds and pence: compare *Gillett v Holt* [2001] Ch 210 at 234-5. The judge so found at [225].

48. Mr Wilson next argued that in evaluating the detriment the judge had not taken account of the fact that this was not a case in which Lucy had made life-changing decisions. The main detriment was financial in nature; and the judge had been able to quantify that. Lucy had always wanted to be a dairy farmer; and had always wanted to farm at Woodrow. She had not given up any other opportunity; and when the farm at Taunton did come up for tender in 2006, Lucy and Stuart's putative bid would have been unsuccessful. But in my judgment, it is not possible to recreate an

alternative life for Lucy in a world without the assurances. As Lord Walker said in *Thorner v Major* at [65]:

‘But it is unprofitable, in view of the retrospective nature of the assessment which the doctrine of proprietary estoppel requires, to speculate on what might have been.’

49. Moreover, to the extent that it matters, the judge’s findings at [123] were that it was the assurances that “kept her at Woodrow;” at [157] that part of the detriment was her commitment to Woodrow “rather than going elsewhere”; and at [207] that if the assurances had not been given, most likely “she would have gone elsewhere, probably sometime in the 1990s”. She would have sought a farming tenancy elsewhere. I do not consider that we can go behind those findings of fact”.

350. Again, therefore, it was a case where the person alleging the estoppel had acted in a particular way, shaping her life around the assurances.
351. In my view the right test is that stated by Robert Walker LJ in *Gillett v. Holt* as quoted above, and is one of substantiality; a broad inquiry as to whether the reliance and detriment are such that it would be inequitable to act contrary to the assurance in question. Whether the person receiving the assurance has acted in a particular way as a result is highly relevant. Inability on the part of the Court confidently to construct a “counterfactual”, because it would be speculative, does not prevent there being a detriment.

Reliance and causation

352. The list of issues that the parties provided referred to the question of “What causative links are required between the representation or assurance, reliance and detriment”. But I do not think there was in fact a dispute, since both cited Neuberger L.J. as he then was in *Steria Ltd v Hutchison* [2006] EWCA Civ 1551 at [117]: but-for causation is not required and the assurance in question need not be the only factor; the person asserting the estoppel need only show that the assurance was a significant factor taken into account by that person in making the decision(s) in question.

FRENCH LAW

353. I have to say a little about the management of the French law issues.
354. The principles of French law said to be applicable were pleaded in five statements of case, two of which were on the pre-trial reading list given to me by the parties. There were four expert reports, two from each of the parties’ experts, Prof Caron (Optis) and Prof Libchaber (Apple). These ran to 100 pages and the reading list included all of them.
355. At the PTR, I was asked to make an Order that there be no oral evidence on French law, hence no cross-examination. I made the Order; this approach has become common, at least in intellectual property cases, where it is anticipated that the

cross-examination would consist merely of putting to the experts written materials which the Court could just read itself. It is done in the expectation that the parties will, at trial and for the purposes of pre-reading, put the Court in the position that it would be if there was cross-examination, by pointing out the key foreign law materials and the arguments on them; in my experience this works well when the parties put in the work to do this. However, I made no formal direction at the PTR about it, although I did raise, and give directions about, the mechanics of agreed translations, which the parties had not tackled.

356. Optis' opening skeleton included detailed submissions about French law with references to the relevant materials. It identified the points in issue, and also said which ones it thought did not actually matter.
357. Apple's skeleton did not do the same. It just said there was extensive agreement between the French experts, which was a true but unhelpful statement. Counsel for Optis objected in his oral opening that Optis did not know where it stood, and I directed that Apple should identify the areas of agreement and of dispute, and explain its position. When, later in the trial, I asked how the exercise was progressing, I was told that there was a *forty* page draft document setting out Apple's position in response to what Optis said. I said that that would not do. No further progress was apparent until written closings, when Apple set out the paragraphs of the French law expert reports which it said were the disputed territory, but still did not tackle the French materials that I would need to consider. That only happened in Apple's post-trial note. At least the number of French law issues in dispute reduced and was reflected in an agreed list (Agreed List of Main French Law Issues, "ALMFLI"); indeed Apple's post-trial note said that "Now that the case has closed, there would appear to be no material difference between the parties as to the principles of French law".
358. This should not have happened. Apple is significantly more to blame than Optis, because it did not communicate, even in its opening skeleton, where it thought the disputes lay or what the Court needed to think about. But both sides should have considered and discussed what was in issue so that I did not have to spend time reading a lot of French evidence and submissions that went to nothing. In retrospect I wish I managed matters more actively at the PTR, and in particular should have thought about directing a meeting of the French experts and an agreed joint memorandum, but whether or not that is so, the end point where the areas of dispute are very few should have been achieved a lot earlier, especially since each party had a legal team dedicated only to the estoppel case and only had to attend half the trial.
359. I remain of the view that with appropriate case management, there will be many instances where cross-examination on foreign law is unnecessary and not the best way to resolve issues of foreign law.
360. In any event, I think Apple's post-trial note was too optimistic in its assertion that there are *no* material issues of French law left, but it is certainly largely true. It is also clearly the case that some matters which could in principle be disputed as to what the proper French law is, are agreed not to matter on the facts of this case. I am not going to try to decide those. In the further interests of proportionality, I

intend to address matters at the level of detail of the parties' closing submissions and the ALMFLI.

Basic provisions

361. The parties agree that the relevant source of law is the 1804 French Civil Code. This contains a number of clauses about contractual interpretation. None of those clauses is mandatory, but the most important is Article 1156:

“One must in agreements seek the common intention of the contracting parties, rather than stop at the literal meaning of the words.”

362. There was an arid debate which I do not intend to address about the proportion of cases in which Article 1156 is or is not referred to in French judgments. The Article is of great importance and applicable in this case.

363. The Civil Code was amended in 2016, and Article 1156 was replaced by Article 1188:

“A contract is to be interpreted according to the common intention of the parties rather than stopping at the literal meaning of its terms.

Where this intention cannot be discerned, a contract is to be interpreted in the sense which a reasonable person placed in the same situation would give to it.”

364. However, it was the 1804 version that was in force at the time of the events with which I am concerned. There was another arid debate about whether the “objective” limb of the second paragraph of new Article 1188 was theoretically available under Article 1156. It was arid because the parties in due course agreed that the “subjective” limb of the first paragraph of the new Article 1188 and Article 1156 both called for a subjective assessment, but allowed the use of objective factors, and that when no subjective evidence was available, the exercise of subjective assessment would in practice depend entirely on objective factors.

365. In any event, the upshot is that I should make an assessment of the common intention of the parties. I may use subjective evidence (e.g. of what the parties actually thought) or objective evidence (e.g. what was the commercial context).

366. It was also common ground that the role of the “literal meaning of the words” is constrained in the way set out in Article 1156. I must not “stop” at them. Various texts refer to this in terms that the “spirit prevails over the letter” or “what has been said matters little, only what has been wanted matters”, or “we must investigate the common intent of the parties rather than focus on the literal meaning of the terms”.

367. It is therefore clear that French law is materially different from English law. It would be pointless as well as very difficult to try to define the exact scope of the difference and unprincipled to try to work out what the answer would be in

English law and then modify it. I must try to work in the same way that a French Judge would.

368. I felt that Apple's arguments gave far too much weight to a detailed semantic analysis of Clause 4.1 and contravened the basic approach of French law that I have just explained.

Clear and Precise

369. A logically prior issue to the task of interpretation as guided by Article 1156 was raised: French law has a concept of contractual clauses which are "clear and precise". Clauses which fit that description are not open to interpretation; Article 1156 does not come into play.

370. It was agreed that the mere fact that there is an argument over the meaning of a clause does not mean that it is not clear and precise; this makes sense and I accept it.

371. There were other peripheral issues about the "clear and precise" concept such as the exact standard required and whether it requires a clause to be clear and precise or only one of them. None of this mattered.

372. I do not intend to delve any more deeply into "clear and precise" since it is obvious that Clause 4.1 does not meet the standard. Two examples will suffice:

- i) There are genuine and substantial questions about the scope and content and purpose of "timely", "reasonable endeavours", and "bona fide".
- ii) There is real and significant difficulty over the relationship of the first and second sentences.

373. I asked for examples where clauses had been held to be clear and precise. The cases in which this has happened are very few, and the instances identified by the parties were far from the present case, e.g. 31 December of one year was clear and precise and therefore could not cover 27 January of the next year; three months was clear and precise and did not cover one month.

374. Where French Courts hold that a clause is clear and precise, it seems to be that they do so in the form of saying that that which is outside the meaning (e.g. 27 January) would be a "*distortion*". Apple seemed to try to make something out of this in its post-trial note. I found the submission hard to follow, but it seemed to be along the lines that if a clause is not clear and precise, and so open to interpretation, then if the result of the interpretation exercise is different from the literal meaning there is a distortion and the clear and precise principle comes back into play. I reject this. The clear and precise principle is a cut-off; if it does not apply then the clause is open to interpretation and that may well lead to a result different from the literal meaning, as Article 1156 makes abundantly clear.

375. The parties agreed that the matters to be taken into account in determining whether a clause is clear and precise go well beyond the words used. Paragraph 8 of the ALMFLI recorded their agreement:

“8. When considering whether a term or language is clear and precise the Court may have regard not only to the term or language itself, but also to other parts of the same contract, and other relevant material relating to or referencing the provision or contract, for example materials from or with a contracting party that reference or relate to or explain the contract or obligation. This is not materially in dispute.”

376. The parties also agreed that this largely matched the very wide range of factors available for the Court’s consideration if interpretation is allowed.

The materials available for the exercise of interpretation

377. Paragraphs 9 and 11 of the ALMFLI said:

“9. There is no single approach for proving the common intent of the parties when interpreting a contract in accordance with the common intent of the parties. When doing so the Court may have regards to *inter alia* the following:

- a. The evidence of the actual intentions of the parties;
- b. The purpose and intended effect of the contract;
- c. The pre- and post-contractual behaviour of the parties;
- d. The wording of the contract as a whole;
- e. Any documentary evidence which might shed light on the common intention of the parties (including, but not limited to, negotiation documents and other similar proposals, both between the parties and between one of the parties and other third parties);
- f. Previous agreements between the parties.

This is not materially in dispute.

...

11. The relevance and weight to be attributed to each factor is a matter for the trial judge.”

378. As to the status of the words of the contract themselves, paragraph 12 of the ALMFLI said:

“Optis contends that the wording of the contract is not treated in a superior manner to any of the other types of evidence. Apple’s position is that when the contract is to be interpreted the weight to be attributed to any particular factor, including the words, will depend on the circumstances of the case.”

379. But I do not think there is any material difference between the parties. It is, I think, important to note that the primacy that English law gives to the words chosen is not present in French law, as indeed Article 1156 makes clear.

380. It is also common ground that the materials to which the Court can have regard are the same whether the inquiry is subjective or objective (save that by definition the latter means that the parties' actual states of mind are not or cannot be considered).
381. Apple submitted that although there is no procedural limit on the documentary evidence to which a French court may have regard identifying the common intention of the parties, that does not mean that all materials are relevant or have the same weight. I agree with this. I think it is particularly important that I should scrutinise the true relevance, if any, of Optis' reliance on the behaviour of declarants to ETSI. That they may have behaved in a particular way does not mean that it was in line with the relevant common intention – they may just have been in breach of their obligations. In addition, what they did is only reflective of their view, as the people subject to Clause 4.1, and without more may be uninformative about the intention of the person entitled to the performance of the obligation (ETSI). I return to this below.

Collective contracts and standard form contracts

382. There was a dispute in the expert evidence about whether the ETSI IPR Policy was a collective contract or a standard form contract, or neither. Apple said I did not need to decide it at all and indeed claimed that Optis agreed. I think Optis was maintaining its position that the ETSI IPR Policy is a standard form contract since it was offered on a take-it-or-leave-it basis. But the only direct significance of this would be that there would be a presumption of interpretation against the party offering the standard terms (ETSI), which could have the effect, in case of doubt, of finding a lesser obligation on Ericsson. I return to the issue of presumptions below.
383. The discussion formed the context of a submission by Apple that it is fruitless or at least difficult to identify the subjective intentions of the parties when the membership of ETSI was constantly changing. I return to this below as well.

Usages

384. These arise in French law when a contract is made in the context of an established usage or trade practice, and there is no agreement to the contrary in the contract. It is relied on specifically, and very narrowly, by Optis, to assert that when ETSI modified its rules in 2005, it did so against the background of the existing pattern of behaviour of post-freeze date declaration. I struggle to see how this one-off event can be said to have established a consistent pattern, or how the unusual fact pattern can be shoehorned into the usage concept generally. That does not make the events of 2005 unimportant – both sides relied on them heavily – but I get no assistance in their analysis from the usage concept.

Means v. Result

385. French law recognises that obligations may be “de moyens” or “de resultat”. The latter requires that the person under the obligation actually achieve the stipulated result. The former requires that the person use what I will call reasonable efforts. The parties appeared to be agreed at this level subject to minor and unimportant

differences over how to characterise reasonable efforts; those differences were expressed in paragraph 21 of the ALMFLI but Apple's post-trial note later said that there was no dispute. It is accepted that in assessing whether there has been performance of an obligation of means the Court should consider all the circumstances of the case.

386. The real crux of this dispute is not over the precise assessment of the level of effort where the obligation is one of means, but over whether the second sentence of clause 4.1 is an obligation of result requiring declaration at the time of the submission of a TDoc covered by a patent application. If it is, then Ericsson would have been in breach, Apple contends.
387. Apple says that the first sentence of clause 4.1 is one of means and this appears to be common ground. One reason why the fine nuances of French law of the content of an obligation of means do not matter, is that Apple simply argues that since Ericsson did nothing at all prior to the stage 3 freeze date, that cannot be reasonable efforts. Optis disputes this characterisation, of course. I return to the application of these principles below.
388. It is not mandatory to use the classification into *moyens* and *resultats*. As with every other principle, it is up to the Judge to assess its utility.

Presumptions

389. It was common ground that two presumptions exist. They were expressed in paragraphs 18 and 19 of the ALMFLI:

“18. Article 1157 provides that where an obligation is susceptible of two meanings, an interpretation which gives it some effect should be preferred to one in which it does not produce any effect. This is not materially in dispute.

19. Article 1162 provides that obligations are to be interpreted in favour of the party subject to them and against the party who has stipulated them. This is not materially in dispute.”

390. However, I have not needed to rely on these presumptions. Similarly, I have not needed to fall back on any presumption arising from the ETSI IPR Policy being a standard form contract.

Interplay of the above principles

391. Paragraph 23 of the ALMFLI says:

“23. The Court may have regards to the same types of materials when (i) interpreting a contract; (ii) considering an obligation of means and (iii) considering the breach (or otherwise) of a clause which is not subject to interpretation; although the weight to be placed upon each of those materials may depend on all of the circumstances. The exercise itself will also be similar in each case, but again may depend on all of the circumstances. This is not materially in dispute.”

392. Thus essentially all the same factors come into play at some point in the analysis, whatever the categorisation applied by the Court.

FACTS RELEVANT TO THE ESTOPPEL ALLEGATIONS

ETSI

393. The following descriptions of ETSI, 3GPP and working methods for the production of standards is intended to be factual, and uncontroversial. I have drawn heavily for this section on Optis' opening skeleton simply to save the time that would be involved in writing it from scratch; Optis' skeleton was closely based on parts of Ms Dwyer's evidence that were not challenged.
394. "SSOs" are Standards Setting Organisations. Some of the evidence and documents in the case used SSO synonymously with Standards Development Organisation ("SDO"); they are not quite the same but the difference was not argued by either side to matter, and I will not try to separate them.
395. There are many SSOs for information and communication technologies. They develop technical specifications that provide in detail the aspects of the subject technologies required for harmonisation and interoperability of products or services.
396. The first generation (1G) commercial wireless cellular systems included Advanced Mobile Phone Service (AMPS) and the NTT System (Nippon Telephone and Telegraph), and were first deployed in the late 1970s and early to mid-1980s. The development of second generation (2G) wireless cellular systems came in the late 1980s and early 1990s.
397. The Groupe Spécial Mobile ('GSM') was formed in 1982 by the European Conference of Postal and Telecommunications Administrations (CEPT), with the goal of developing a common European mobile telecommunications service which would allow users to roam in all of the CEPT countries. The standardisation process for the GSM system was set up in 1983 by CEPT. In 1985 the European Commission endorsed the GSM project, followed by EU Heads of State endorsement in 1986, and the first technical specification was made available in 1987.
398. The first discussions relating to the creation of a European Telecommunications Standards Institute ('ETSI') began in 1987 when the European Commission raised the idea. The Directors-General of CEPT decided to establish ETSI.
399. ETSI was created in January 1988. It is the European regional standards body dealing with matters including telecommunications, broadcasting and other electronic communications networks and services. Although ETSI was initially founded to serve Europe, it is now a leading standards setting organisation for cellular wireless telecommunications world-wide.
400. The General Assembly (GA) is the highest authority of ETSI with responsibility for policy and strategy. It has the authority to determine the general policy and

Rules of Procedure that are mandatory for all ETSI Members. The GA has the authority also to decide on disputes arising from the application of the ETSI Rules of Procedure, including the sanction of ETSI Members. Ms Dwyer was unaware of any member ever being sanctioned, however.

401. The ETSI Board looks after routine business of ETSI.
402. The ETSI Secretariat includes the ETSI Director and Deputy Director. The ETSI Director is the legal representative of ETSI, and the Secretariat is responsible for administrative tasks.
403. The Technical Committees (TCs) of ETSI were established to “*provide a forum for consensus building among European technical experts in developing new standards*”. The TCs were charged with submitting proposals for draft standards for approval.

3GPP

404. The 3rd Generation Partnership Project (‘3GPP’) was formed in December 1998 with the purpose of developing new technology specifications for global 3G cellular standards. It is a partnership project and not a legal entity itself.
405. 3GPP was formed by SDOs from around the world to be the technical committee responsible for producing technical specifications of global scope, to be transposed by the SDOs into regional standards. The SDOs that make up 3GPP are also called ‘Organisational Partners’. Five Organisational Partners originally joined together with ETSI to form 3GPP in 1998: (ARIB (Japan), TTC (Japan), TTA (South Korea), ATIS (US)), with a sixth (CCSA (China)) joining shortly thereafter in 1999, and a seventh Organisational Partner (TSDI (India)) joining in 2015.
406. 3GPP is not a Standards Development Organisation. Technical standards are created by the above-mentioned transposition of the 3GPP technical specifications into standards by the SDOs. The adoption process is one of transcription. A technical specification is adopted by a 3GPP partner SDO when that SDO publishes the specification with its own coversheet.
407. Companies that are members of one of the 3GPP Organisational Partners may become members of 3GPP, although being a member of an Organisation Partner does not automatically confer 3GPP membership. Not all ETSI Members are members of 3GPP.
408. 3GPP consists of a Project Co-ordination Group (“PCG”) which oversees all of 3GPP, and Technical Specification Groups (“TSGs”), which coordinate and approve the work performed in their associated Working Groups through Plenary Meetings which are held quarterly. The structure is:

Project Co-ordination Group (PCG)

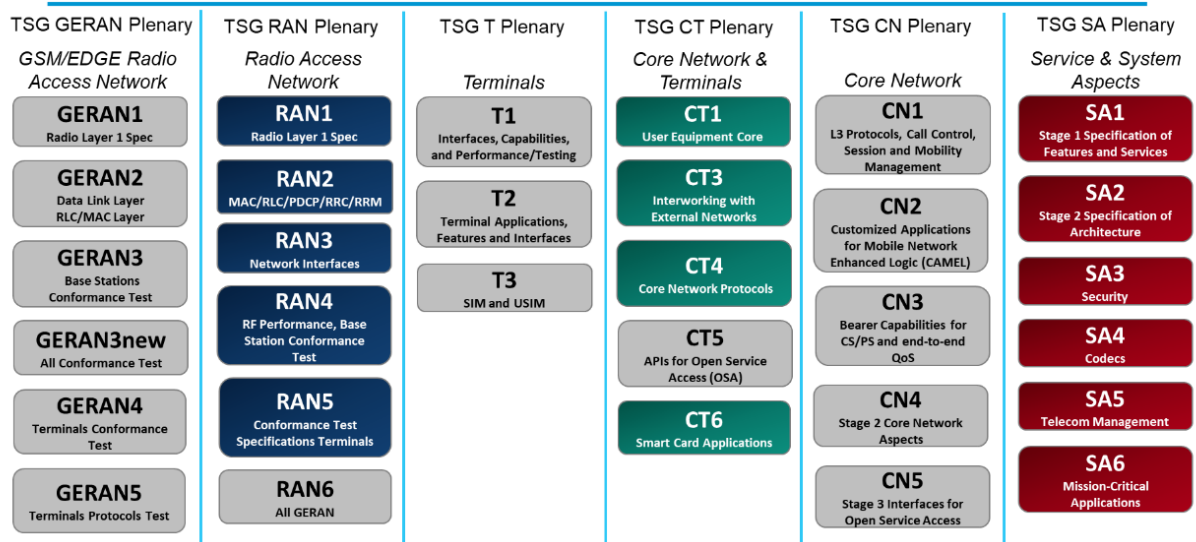

409. Technical work in 3GPP is driven by contributions from 3GPP members. There is no independent central R&D section within 3GPP.
410. At the earlier stages, the control of technical specifications and technical reports is somewhat informal, under the control of the relevant WG. Proposals are submitted to the WG in the form of “temporary documents”, known informally as “TDocs”.
411. When they become sufficiently stable, the technical specifications and technical reports come under “change control” of the respective TSG, following which all additions and changes must be presented as a formal type of TDoc known as a “Change Request” or CR. A CR illustrates the changes that are needed in various 3GPP technical specifications to implement the agreed solution.
412. TDoc proposals may be updated, rejected, changed, or combined with other proposals, and new proposals may be brought forth.
413. 3GPP RAN WG2, which I have already mentioned, is the working group relevant to this case. It held 9 meetings in 2007, 10 in 2008, 10 in 2009, and 9 in 2010.
414. Technical discussions frequently also take place in offline sessions and over “email reflectors” (which are a way of sending emails to all other group members).
415. Once consensus has been reached within the WG, CRs are presented to the TSG plenary for approval at its quarterly meetings, during which CRs will be accepted, amended or remitted back to the WG for further consideration.
416. Technical specifications are developed in four stages:
- i) Stage 1 is an overall service description from the user's standpoint;

- ii) Stage 2 is an overall description of the organisation of the network functions to map service requirements into network capabilities;
 - iii) Stage 3 is the definition of switching and signalling capabilities needed to support services defined in stage 1; and
 - iv) Stage 4 is the production of test specifications. Within 3GPP this is referred to as the 'TTCN' stage.
417. The functionality of a specification is evolved and improved over time, and new features and improvements to existing features are continually being developed to meet the growing need for high speed, low latency connectivity. 3GPP organises these new features into "Releases". A Release is an organised collection of technical specifications that taken together completely describe the entire operation of some aspect of system functionality.
418. Within UMTS (3G), and following that LTE (4G) and 5G, technical specifications are numbered using a 'version' system of three digits: x.y.z. The "x" field gives the Release number. The "y" field is the version number, and is incremented every time technical changes are introduced into the specification. The "z" field is incremented when a purely editorial change is made.
419. The original GSM Releases were described differently: the first two Releases were 'GSM Phase 1' and 'GSM Phase 2', followed by 'R96', 'R97', and 'R98'. Release-99 was the first UMTS specification, although it was actually frozen in 2000. This was rebranded as Release 4, followed by Release 5 etc.
420. The events to which this trial particularly relates concern 3GPP TS 36.322, the radio link control (RLC) protocol specification for LTE. Since this is an LTE standard, the first Release of this technical specification was Release 8, which was adopted and published by ETSI as technical standard 136.322.
421. Releases are ascribed a 'freeze date' by 3GPP, the date after which no new functionality can be added to that Release. However, after the freeze date the detailed protocol specifications of Stage 3 may still change as further refinements and corrections are made.
422. The TTCN (stage 4) freeze date, which marks when the protocols test case coding is complete, is also referred to as the 'end date'.
423. In the case of Release 8, the 3GPP stage 3 freeze date was 11 December 2008, and the end date was 12 March 2009. Nonetheless further changes to Release 8 of this technical specification occurred in June 2010. People are not always precise or unambiguous as to whether they mean stage 3 or stage 4 when they refer to "the freeze date", but in the present case it does not matter as Ericsson only declared in relation to the Patent after both had occurred for Release 8. I note in passing that Apple's contention is that the requirement of the first sentence of Clause 4.1 is to declare prior to the stage 3 freeze date, and I have tried to reflect that in this judgment, but as I say it does not matter which for any

substantive reason, and both in written and oral argument there was a tendency to refer to “the freeze date”, and I have done the same in many instances.

424. ETSI maintains a publicly accessible database of declarations by IPR holders of rights which the declarant considers to be essential to working a standard. ETSI does not assess whether the rights in question are essential. Mr Rodermund accepted, and I find, that apart from administrative tasks, ETSI does not consider or use the contents of the IPR database at all.

Working groups, meetings, submissions

425. I make the following findings about WGs’ operation and meetings:

- i) WGs operate by consensus. This means that proposals made in TDocs are debated and refined until there is no sustained objection. It may seem remarkable that so many people can reach this level of agreement on such complex subjects, especially given that they are commercial competitors, but that is what happens. It is an extraordinary achievement that this level of agreement is achieved time and again, over the enormous scope of the standards.
- ii) WG discussions almost never touch on intellectual property matters. It is not just that raising such matters does not happen: it is regarded as positively not allowable because of competition concerns if WG members were to be seen to be making agreements about IP. In a tiny number of instances identified in these proceedings where IP was mentioned (usually in the email reflectors) it was quickly deprecated, and stopped. The instances were so few that I think they can be ignored altogether. As I have mentioned in connection with his assessment as a witness, Mr Rodermund’s report said that IP was discussed sometimes, but he retreated from that in cross-examination more or less entirely.
- iii) WG meetings involve intense preparation and there are very many TDocs to consider. By way of example, at one of the meetings where the Ericsson TDoc was presented, there were 663 TDocs submitted. About 10 or 20 proposals might be made for a single feature.
- iv) A technical proposal might generally take about three or four months to get into the relevant specification under discussion.

426. I find that a large proportion of the inventions underlying potentially essential patents were made close in time to WG meetings when the engineers involved focused on the specific technical problems relevant to the parts of the standard they were working on. It is impossible and unnecessary to put a precise figure to the proportion of declared essential patents that fell into this category. In such circumstances:

- i) It was common to file a patent application in very similar terms to the TDoc just before provision of the TDoc to a WG. Otherwise, the TDoc would anticipate any later application.

- ii) In such cases, the patent application would most probably be unpublished at the freeze date.
- iii) It was common for the inventor to participate at the WG, since they understood the invention and could advocate for it.
- iv) It would be easy for the employer of the inventor to know that the TDoc and the patent application were connected and for the same thing, although making the link would require the cooperation of the engineers and the patent department.

427. There were also instances where pre-existing IPR was put forward and adopted into a technical specification.

428. At WG meetings (whether ETSI or 3GPP) there was a “Call for IPR”. This was a formal reminder by the Chair, which was minuted, about the need to declare IPR. I find that it was routinely made, but that it was not intended to result, and did not result, in participants declaring IPR at the meetings. The Call for IPR took a different form in ETSI and in 3GPP. Since 3GPP did not have its own IPR policy, as I explain below, the Call for IPR at 3GPP meetings consisted of a reminder of the IPR policies of its partner organisations, which included ETSI.

Declaration timing

429. A major part of Optis’ case concerned timing of declarations. The great majority of declarations were made after the stage 3 freeze date. The following summary is from Optis’ evidence (Ms Dwyer’s first report, Table 95), and was not challenged (it also gives data with respect to the TTCN freeze date):

3GPP Release	Stage 3 Freeze Date	% Disclosure After Stage 3 Freeze Date		TTCN Freeze Date	% Disclosure After TTCN Freeze Date	
		ALL ETSI	Apple		ALL ETSI	Apple
3	17 December 1999	100.0%		17 December 1999	100.0%	
4	22 March 2001	100.0%		21 June 2001	100.0%	
5	14 March 2002	63.3%	100.0%	12 September 2002	62.9%	100.0%
6	17 March 2005	58.7%	100.0%	28 September 2005	57.1%	100.0%
7	15 March 2007	92.0%	100.0%	13 March 2008	82.4%	41.7%
8	11 December 2008	96.7%	100.0%	12 March 2009	94.7%	100.0%
9	10 December 2009	99.2%	100.0%	25 March 2010	98.4%	100.0%
10	23 March 2011	98.9%	100.0%	08 June 2011	98.6%	100.0%
11	12 September 2012	96.8%	81.6%	06 March 2013	94.9%	81.6%
12	17 September 2014	99.4%	100.0%	13 March 2015	91.2%	97.7%
13	11 December 2015	99.5%	99.5%	11 March 2016	95.2%	99.5%
14	10 March 2017	89.3%	100.0%	09 June 2017	83.7%	100.0%
15	22 March 2019	55.5%	69.6%	07 June 2019	49.1%	69.6%
16	03 July 2020	18.5%	0.0%	03 July 2020	18.5%	0.0%

Table 95 - Declaration Timing vis à vis Stage 3 and TTCN Freeze Dates for Various 3GPP Releases

430. The present case focuses on Release 8 when the all-ETSI figure was 96.7% and, for Apple, 100%. Also relevant are earlier periods, for assessing what was the situation when the current form of Clause 4.1 was adopted in 2005.

431. Ms Dwyer (in her second report, Table 1, also not challenged) showed the proportion of companies making IPR declarations that did so after the stage 3 freeze date:

Percentage of the time that declarations were made after the Stage 3 Freeze Date	Number of companies	Percentage of companies
100%	55	52.9%
50% - 99%	38	36.5%
Less than 50%	11	10.6%
Total	104	100%

432. Thus just over half the companies declared after the stage 3 freeze date 100% of the time, and most of rest declared after that date between 50% and 99% of the time.
433. These figures cannot be directly correlated to situations where a TDoc was submitted at the same time as a patent application, but that does not detract from the very strong overall pattern of consistent declaration after the stage 3 freeze Date across the board.
434. Only a minority of ETSI members have declared IPR to 3GPP standards. Very roughly, there have been about 100 declarants out of about 800 ETSI members.

Awareness of declaration timing

435. Apple questioned whether, if there was indeed a practice of filing after the stage 3 freeze date, it was known to other ETSI participants. Optis called this the “no-one knew” point.
436. It is obvious that the practice not only existed but was widely known. The fact that the great majority of companies declared after the stage 3 freeze date speaks for itself, and, as I explain below, it was a big part of Apple’s case that the Commission was actively concerned about late declaration when it raised the issue over the ETSI IPR Policy in 2005, leading to what I have found was a very active debate within ETSI and the AHG and its Report. I find that it was well known, both to declarants and the ETSI membership generally, that most declarations were made after the stage 3 freeze date.

How declarations were made

437. IPR declarations to ETSI could be made either in respect of specified patents or patent families, or by a general licensing declaration with respect to one or more specific standards or technical specifications, or even for all ETSI standards or technical specifications.
438. Until April 2002 it was compulsory to declare on paper. In April 2002 ETSI provided an ‘IPR Statement and Licensing Declaration’ form (‘ISLD’ form), but it was not obligatory until November 2008.

439. From January 2007 ETSI enabled declarations via an online entry system. Optis' evidence (from Mr Carpenter, and not challenged) was that around 72% of ISLD's submitted to ETSI from 2008 – 2010 were on paper.
440. Many of the fields on the ISLD and online form were not mandatory. A lot of the detail does not matter, but it is relevant for me to have in mind how often the 'illustrative specific part' field was completed, because that information was part of what Mr Rodermund said could be used to match a TDoc to a patent application if someone wanted to do that. Mr Carpenter's analysis was that it was only in about 20% of cases that the field was completed.
441. Declarations do not appear on the ETSI database immediately upon being made. There is a lag. This was referred to as the "reflection" period. It was about 90 to 150 days, i.e. 3 to 5 months, although for online declarations it was a good deal less, up to about 30 days.

Assessment of essentiality

442. As I have said, ETSI did not scrutinise whether IPR declared to it actually was essential. Declarants did that themselves. Deciding whether a patent or patent application was essential to part of a standard was, I find, not straightforward because both the patent/application and the standard would be subject to change. The patent/application might well be rejected by patent offices that considered it, or amended over prior art, for example. It was therefore a matter of judgment whether declaration was essential, and the uncertainty over it could, in general, reduce over time.

Whether WG participants checked the IP status of TDocs

443. I find that there was in fact no practice of WG participants checking to see whether TDoc proposals up for discussion in a forthcoming meeting were or might be covered by IP. The evidence is overwhelming, but in particular:
- i) There is not a single example in the evidence before me of it ever happening.
 - ii) Apple had a strong incentive to find examples if they existed (not only for this case but also the Texas litigation), and the resources to do so. The amounts at stake would have justified the effort. I infer that it has looked and failed to find any. There have been many WG participants over the years and while many still work for their companies and owe continuing duties of confidentiality, others will have moved on or retired and would be available as witnesses (as Mr Rodermund and Ms Dwyer are).
 - iii) There was no point in WG participants looking for declarations in the ETSI database as a starting point for such a check, since participants nearly all declared after the freeze date.
 - iv) Declarations that were submitted before the freeze date might well not be on the database until after the freeze date because of the reflection period.

- v) Even to the extent declarations of IP were made by TDoc proposers in time for them to be available for study prior to a WG meeting, matching a declaration to a TDoc would have been very difficult. This would be even more difficult (if possible at all) for unpublished patent applications. Reasons included the fact that declarations mostly did not include the “illustrative specific part” field. Mr Rodermund suggested that it might be possible to match dates of patent applications, TDocs and declarations, but that would depend on declarations being made at the same time as TDocs, and even if they were I think his idea, which is untested, was very implausible and would have been extremely laborious with little reasonable expectation of good or reliable results.
 - vi) There was no incentive to do any such checks, since even if IP were identified, a WG participant who did so would not be able to make an argument that the presence of IP was a reason to reject a TDoc, or to discuss such a notion with other participants. All he or she could do would be to make arguments against the technical merits of the TDoc, which would then be accepted or rejected based on its technical merit in any case.
 - vii) The run up to WG meetings was a very busy time for all concerned with a huge number of TDocs to assess for their technical merit. That work, and not IP checks, was the priority.
 - viii) The overall goal of WG participants was to arrive at the best technical solution.
 - ix) It was a fact of life that ETSI standards, because they were innovative in many respects, would be subject to IP. There was a strong incentive to make sure that essential IP was subject to effective FRAND undertakings (although this was not the job of the WGs), but very little motivation, if any, to make marginal changes to how many patents were essential
444. I have already mentioned the lack of incentive to check whether TDocs were covered by IP because even if they were, or were thought to be, a WG participant could not raise the topic as such, but only advocate for a different technical solution on technical grounds. As to this:
- i) Apple laid extremely heavy emphasis on some passages of the cross-examination of Ms Dwyer where, it submitted, she had accepted that individual members of ETSI who sent delegates to WGs “can” take licensing costs into account in their selection of the best technical solution. She said that “cost might be considered”. She said that where information on costs was available “it may influence companies’ positions, and, yes, ultimately that may influence the outcome.” This was on day 4, pages 579-589.
 - ii) In view of Apple’s heavy reliance, I have re-read this evidence with particular care. In my view she was not accepting any such influence on the outcome as being realistic; at most she was accepting that it was theoretically possible.

- iii) Ms Dwyer cogently made the point that since WGs work by consensus, it would not be practical to oppose what was in fact the best technical solution in this way, let alone in the sustained fashion necessary to block a consensus.
- iv) The questioning also muddled up, or was confusing over, licensing costs with whether patent applications might exist.
- v) As with the issue of whether WG participants tried to check TDocs against IP, there is no example in the case of a WG participant advancing a technical argument against a TDoc in order to inhibit its adoption for IP reasons. Of course this would not be obvious on the face of what was said in the meeting, but for reasons given above, witnesses who had seen it done by their own organisations could have been sought.

What RAN WG2 participants would have thought about the Ericsson TDoc

445. For the reasons already given, I do not think that any thought would have been given by RAN WG2 participants to whether or not there was likely to be IPR associated with the Ericsson TDoc. But if there had been, I find that in the circumstances of:

- i) RAN WG2 being a “patent heavy” working group;
- ii) Ericsson being a well-known innovator, patent filer and WG participant;
- iii) The TDoc for the application which ultimately led to the Patent being presented as a solution for a new problem arising in LTE;

any WG participant who had thought about whether Ericsson was likely to have IPR over the TDoc, would conclude that from those circumstances, and regardless of whether Ericsson had made a declaration, that it was very likely, such IPR being in the form of a patent application. This is what Ms Dwyer said, and Mr Rodermund essentially agreed, merely qualifying his answer by saying that not all proposals had associated IPR.

446. I find that if, contrary to what actually happened, Ericsson had made a declaration associated with the Ericsson TDoc at the time of the relevant RAN WG2 meetings, it would have been relatively uninformative because it would have been in relation to an unpublished patent application.

447. I find that the perceived degree of likelihood of there being an Ericsson patent application which actually covered the Ericsson TDoc would not have been materially different whether it was inferred from the circumstances, or from a contemporary declaration by Ericsson (had it made one). Counsel for Apple argued that a declaration carried extra conviction and was more apt to raise a “red flag”, but I disagree. One has to assume for this point that a WG participant was motivated to check. The surrounding circumstances would found a powerful but not absolute inference, and a declaration would do likewise, with the uncertainty arising from not being able to see an (ex hypothesi) unpublished application and the difficulties of relating it to a particular TDoc.

Available alternatives

448. Apple relied on three documents as being potential technical alternatives to the Ericsson TDoc proposal:

- i) The Motorola TDoc pleaded as prior art but dropped;
- ii) The InterDigital TDoc prior art;
- iii) The Pani PCT prior art.

449. These were potentially important because if Apple had shown that there was a relevant assurance, the issue would arise of whether it made any difference. To put it another way: if WG members had expressly been told about the Ericsson provisional application, and had been motivated to consider the IPR position of the Ericsson TDoc, what would they have done? Part of Apple's answer is that they would or might have adopted Motorola, InterDigital, or Pani instead.

450. My view is that there was no relevant assurance and that WG members did not make decisions about TDocs based on IPR. However, I make the following factual findings in case I turn out to be wrong:

- i) WG members would, if they considered it, have thought that Motorola was likely to be covered by a patent application. The evidence on this was from Mr Boué-Lahorgue and from Ms Dwyer and I found the latter's evidence more convincing.
- ii) No Motorola application has even been identified but that does not mean that there was not one. An application covering it might well have been abandoned before publication.
- iii) There is no evidence that Motorola was as good a solution as that of the Patent and it probably was not; it just presented a menu of possible alternatives.
- iv) Motorola was actually an LTE TDoc presented to RAN WG2. If it was the best solution it probably would therefore have been considered and adopted.
- v) InterDigital was a UMTS proposal and therefore would not have come to the attention of RAN WG2 for LTE.
- vi) Similarly, it would have been thought, had the matter been considered, that InterDigital was probably covered by a patent application (InterDigital being a vigorous applicant for patent protection).
- vii) Pani is a PCT and therefore obviously subject to IP but in any event was not published in time to be considered at the relevant meetings.
- viii) Overall, I draw the inference that the Patent's solution was the best of anything of which RAN WG2 for this LTE release was aware, or could reasonably have been aware.

451. Apple's opening skeleton on the technical issues asserted that any of the solutions from Mr Kubota's TDoc analysis could have been adopted. This contention was not supported by evidence in the sense of evidence that they might have been as good or better than the Patent's solution, was not pleaded (so far as I can tell) and was not put in cross-examination. I reject it.

ETSI IPR Policy over time

452. I have said already that the ETSI IPR Policy is not clear and precise in terms of the test in French law. I therefore have to interpret it. Given my conclusions on French law, I should adopt a subjective approach, but this involves many factors including objective ones, i.e. ones bearing on what a reasonable person would understand.

453. I accept Apple's submission that in the circumstances of this case I cannot meaningfully identify the subjective intentions of ETSI members as to the scope of Article 4.1. Neither Ericsson nor Apple has given evidence and in any event the events in question span a long period; there have been many ETSI members and their interests and subjective views no doubt differ, in particular as between patent holders and non-patent holders.

454. On the other hand ETSI's subjective intentions can be identified quite clearly, because it "shows its working" – its meeting and its policy objectives are documented. These are generally not the subjective thoughts of named individuals on particular issues at stated times (although some key individuals have played significant, identifiable roles), but they show what the organisation was trying to achieve by the contractual language chosen. Even if I were wrong and French law would not call this subjective interpretation, it is clearly open to me to take account of it as an objective factor.

455. The parties made submissions on a large number of points of detail about the history of the ETSI IPR Policy. It is not proportionate to deal with them all, but I deal with the main points of the history below. Before I do that, I will make some points about the relative utility of the materials I was shown, and state what I think the key points to emerge were.

456. As to the utility of the materials:

- i) I consider it key to decide what *ETSI's* intentions were. Statements of desire of individual members can have little weight. For example, Optis sought to rely on specific proposals by Italtel and Fujitsu in 1994; I have no way of knowing if they represented the general views of ETSI members.
- ii) Proposals that were not adopted are of only limited use individually, although there is modest force in Optis' point that various tougher provisions (in the sense of hard-edged rules, or rules backed by sanctions) were proposed but not accepted. More relevant are changes that did take place, and the reasons for them.
- iii) Competition law theory in itself is of limited significance. The way in which ETSI fed its understanding of competition law into the ETSI IPR

Policy is more important, and its discussions with the Director of the European Commission's Competition Directorate-General ("DG Comp") in and around 2005 are important for the same reason.

- iv) Discussions and documents that were explored in the written expert evidence are more useful than those that were put in only in cross-examination materials at trial.

457. As to the key points from the history, I consider them to be:

- i) There was a 1993 Interim IP Policy and an Associated IPR Undertaking. It was unpopular with patent-owning members for a variety of reasons. For present purposes, the main point is that it had a fixed 180-day time limit from a standard's adoption for a patentee to identify essential IPR and remove it from what was in general a licence by default scheme.
- ii) Following complaints from members, pressure from the European Commission, and US Government lobbying, a revised Interim IPR Policy was adopted by the General Assembly of ETSI in 1994. I set out key provisions below. Its Clause 4.1 had the same structure as the current Clause 4.1 the subject of these proceedings, subject to changes I discuss below.
- iii) In 1997 the 1994 Interim IPR Policy was made definitive.
- iv) In 1998 ETSI signed up to the 3GPP Partnership Agreement.
- v) In 2002/2003 there was a review (the "Ad Hoc Group Review" or "AHG Review") of the IPR Policy. One reason was that the Chair of an ETSI technical committee had written to the Director General proposing changes, which included that documents presented to Working Groups (i.e. including TDocs) should include a pro forma statement of IPR content, and that members should have to renounce IPRs that were not declared in a timely fashion. These were not accepted. I refer to some key events during the review.
- vi) Following the AHG Review, the 2004 IPR Guide was published. I refer to sections of this below.
- vii) Starting at the end of 2004 but mainly taking place in 2005, there was a discussion between DG Comp and ETSI over the IPR Policy and in particular clause 4.1. DG Comp disliked the vagueness of the "timely" requirement in the first sentence of clause 4.1. ETSI resisted this change, and "timely" was retained, although moved around in the sentence; however, the words "in particular during the development of a STANDARD or TECHNICAL SPECIFICATION" were added. I refer to some key events below.
- viii) This led to a new version of the IPR Guide being produced, with a new section 4.5, written by DG Comp. I set this out below.

458. What is clear, to my mind, is that ETSI has consistently taken the approach that:
- i) The key objective was to achieve the best technical solution.
 - ii) It was inevitable that members would have essential patents covering ETSI standards and there was nothing wrong with that in itself.
 - iii) “Late” disclosure was only a problem if a licence was not available for the IPR concerned, or if one was not available on FRAND terms.
459. In addition, I think it is very important to note the importance ETSI attached to *encouraging* early disclosure. Its powers of compulsion (using that word somewhat loosely) and of remedial action were reserved for the situation where no FRAND licence was available for essential IPR.
460. Taking these events in the round, I think particular importance attaches to the events of 2005. It was at that point that the current relevant language of Clause 4.1 was chosen, against a background where DG Comp was pressing for greater strictness and ETSI was resisting it.
461. With that, I turn to the specific points and statements of the history. I do not think there is anything that I usefully need quote from the 1993 Interim IP Policy, so I start after that.

The 1994 Interim IPR Policy

462. I have explained the context of this above. Key provisions were as follows.
463. Clause 3 set out the policy objectives of the ETSI IPR Policy:

“3. Policy Objectives

3.1 STANDARDS and TECHNICAL SPECIFICATIONS shall be based on solutions which best meet the technical objectives of the European telecommunications sector, as defined by the General Assembly. In order to further this objective the ETSI IPR POLICY seeks to reduce the risk to ETSI, MEMBERS, and others applying ETSI STANDARDS and TECHNICAL SPECIFICATIONS, that investment in the preparation, adoption and application of STANDARDS could be wasted as a result of an ESSENTIAL IPR for a STANDARD or TECHNICAL SPECIFICATION being unavailable. In achieving this objective, the ETSI IPR POLICY seeks a balance between the needs of standardization for public use in the field of telecommunications and the rights of the owners of IPRs.

3.2 IPR holders whether members of ETSI and their AFFILIATES or third parties, should be adequately and fairly rewarded for the use of their IPRs in the implementation of STANDARDS and TECHNICAL SPECIFICATIONS.

3.3 ETSI shall take reasonable measures to ensure, as far as possible, that its activities which relate to the preparation, adoption and application of STANDARDS and TECHNICAL SPECIFICATIONS, enable STANDARDS and TECHNICAL SPECIFICATIONS to be available to potential users in accordance with the general principles of standardization.”

464. Clause 4 set out the disclosure obligations within the ETSI IPR Policy:

“4. Disclosure of IPRs

4.1 Each MEMBER shall use its reasonable endeavours to timely inform ETSI of ESSENTIAL IPRs it becomes aware of. In particular, a MEMBER submitting a technical proposal for a STANDARD or TECHNICAL SPECIFICATION shall, on a bona fide basis, draw the attention of ETSI to any of that MEMBER's IPR which might be ESSENTIAL if that proposal is adopted.

4.2 The obligations pursuant to Clause 4.1 above do however not imply any obligation on MEMBERS to conduct IPR searches.”

465. This is the forerunner of Clause 4.1 which Apple says that Ericsson breached in 2008.

466. Clause 6 set out the rules in respect of the availability of FRAND licences:

“6. Availability of Licences

6.1 When an ESSENTIAL IPR relating to a particular STANDARD or TECHNICAL SPECIFICATION is brought to the attention of ETSI, the Director-General of ETSI shall immediately request the owner to give within three months an undertaking in writing that it is prepared to grant irrevocable licences on fair, reasonable and non-discriminatory terms and conditions under such IPR to at least the following extent:

- MANUFACTURE, including the right to make or have made customized components and sub-systems to the licensee's own design for use in MANUFACTURE;
- sell, lease, or otherwise dispose of EQUIPMENT so MANUFACTURED;
- repair, use, or operate EQUIPMENT; and
- use METHODS.

The above undertaking may be made subject to the condition that those who seek licences agree to reciprocate.

6.2 At the request of the European Commission and/or EFTA, initially for a specific STANDARD or TECHNICAL SPECIFICATION or a class of STANDARDS/TECHNICAL SPECIFICATIONS, ETSI shall arrange to have carried out in a competent and timely manner an investigation including an IPR search, with the objective of ascertaining whether IPRs exist or are likely to exist which may be or may become ESSENTIAL to a proposed STANDARD or TECHNICAL SPECIFICATIONS and the possible terms and conditions of licences for such IPRs. This shall be subject to the European Commission and/or EFTA meeting all reasonable expenses of such an investigation, in accordance with detailed arrangements to be worked out with the European Commission and/or EFTA prior to the investigation being undertaken.”

467. Clause 8 set out the procedure that should be followed if a member notified ETSI that they are not prepared to grant a licence of an essential IPR:

“8. Non-availability of Licences

8.1 MEMBERS' refusal to license

8.1.1 Where a MEMBER notifies ETSI that it is not prepared to license an IPR in respect of a STANDARD or TECHNICAL SPECIFICATION, the General Assembly shall review the requirement for that STANDARD or TECHNICAL SPECIFICATION and satisfy itself that a viable alternative technology is available for the STANDARD or TECHNICAL SPECIFICATION which:

- is not blocked by that IPR; and
- satisfies ETSI's requirements.

8.1.2 Where, in the opinion of the General Assembly, no such viable alternative technology exists, work on the STANDARD or TECHNICAL SPECIFICATION shall cease, and the Director-General of ETSI shall request that MEMBER to reconsider its position. If the MEMBER decides not to withdraw its refusal to license the IPR, it shall inform the Director-General of ETSI of its decision and provide a written explanation of its reasons for refusing to license that IPR, within three months of its receipt of the Director-General's request.

The Director-General shall then send the MEMBER's explanation together with relevant extracts from the minutes of the General Assembly to the ETSI Counsellors for their consideration.

8.2 Non-availability of licences from third parties

Where, in respect of a STANDARD or TECHNICAL SPECIFICATION, ETSI becomes aware that licences are not available from a third party in

accordance with Clause 6.1 above, that STANDARD or TECHNICAL SPECIFICATION shall be referred to the DirectorGeneral of ETSI for further consideration in accordance with the following procedure:

i) The Director-General shall request full supporting details from any MEMBER who has complained that licences are not available in accordance with Clause 6.1 above.

ii) The Director-General shall write to the IPR owner concerned for an explanation and request that licences be granted according to Clause 6.1 above.

iii) Where the IPR owner refuses the Director-General's request or does not answer the letter within three months, the Director-General shall inform the General Assembly. A vote shall be taken in the General Assembly on an individual weighted basis to immediately refer the STANDARD or TECHNICAL SPECIFICATION to the relevant COMMITTEE to modify it so that the IPR is no longer ESSENTIAL.

iv) Where the vote in the General Assembly does not succeed, then the General Assembly shall, where appropriate, consult the ETSI Counsellors with a view to finding a solution to the problem. In parallel, the General Assembly may request appropriate MEMBERS to use their good offices to find a solution to the problem.

v) Where (iv) does not lead to a solution, then the General Assembly shall request the European Commission to see what further action may be appropriate, including nonrecognition of the STANDARD or TECHNICAL SPECIFICATION in question.

In carrying out the foregoing procedure due account shall be taken of the interest of the enterprises that have invested in the implementation of the STANDARD or TECHNICAL SPECIFICATION in question.”

468. I have explained the relevance of the provisions of clauses 6 and 8 to “patent ambush” above.
469. Clause 12 stipulated French law, and clause 14 provided that a violation of the Policy was a breach of the member’s obligations to ETSI, with the GA having the authority to decide what action, if any, to take.
470. Clauses 6.1, 8, 12 and 14 have not changed materially since.

3GPP Partnership Agreement

471. In December 1998 ETSI signed the 3GPP Partnership Agreement. The provision of it particularly relied on by Apple was clause 3 whereby ETSI and the other Organizational Partners agreed to:

“... encourage that their IPR Policies are respected by their members (i.e., encourage their members to declare at the earliest opportunity any Intellectual Property Rights which they may have and believe to be essential, or potentially essential, to any ongoing work within 3GPP) ...”

472. I did not find this very significant. It is not an IPR Policy as such and did not directly affect the IPR Policies which the Partners had. It contained an *encouragement* for the earliest possible declaration, but not a hard-edged obligation.

2003 AHG Review

473. The Ad Hoc Group met six times over the course of the year, and in November 2003, submitted a report to the General Assembly (the “**Ad Hoc Group Report**”). The General Assembly accepted the recommendations contained within the Ad Hoc Group Report.

474. Section 4.1 of the Ad Hoc Group Report discussed the timely disclosure of essential IPRs:

“4.1 Timely disclosure of essential IPRs

It seems obvious, that if essential IPRs in an ETSI Standard are not disclosed in a timely, manner there might be severe consequences. But, more surprisingly, there are also difficulties in making timely disclosures. These issues are summarised below.

A lack of timely disclosure (or the lack of an available undertaking) would delay commencement and hence delay completion of negotiations on the detail of licenses, which may delay market entry. If this occurs, the resulting delay in the implementation of a product may place a company in a difficult situation. This happens even if licenses are ultimately available on ETSI IPR policy terms. In particular, there is uncertainty over the outcome of negotiations over the details of the licenses which has to be resolved before a product can be launched.

[...]

The main task of a Technical Body is the search for the best technical solution and that the existence of essential IPRs is not a barrier. Non-disclosure of essential IPR in a specific technical solution is not a problem for the Technical Body unless, ultimately, licenses are not available under

FRAND conditions (see section 4.4). If this happens, then a standard could become blocked by the nonavailability of IPR licenses on terms that meet ETSI's IPR policy. The committee would then be asked to re-write the standard.

Furthermore, ETSI also needs to deal with timely disclosure in the context of a publicly available specification or other document offered to ETSI for publication.

The concept "timely" is already documented, in terms of points where disclosures could or should be made:

- On formal submission of a technical solution,
- On completion of the first stable draft of the Standard,
- On working group approval of a draft Standard,
- On Technical Body approval of a draft Standard.

It was agreed that a formal of definition "timely" would be a change to the policy, so the aim of the recommendations here is to refine the advice to Members and to promote the achievement of "timely disclosure" rather than to define the concept."

475. In terms of timing, this discussion references the difficulty of beginning licensing discussions if appropriate declarations have not been made. This is a different point from that which Apple makes in the present case. Apple did not suggest that for licensing purposes it mattered whether a declaration was made before or after the freeze date, and common sense would suggest that licensing discussions might only start some time later.
476. It is also pertinent that a decision was made not to change the policy but to refine advice and promote timeliness in general.
477. Recommendations 1 to 6 were proposed in respect of the issues discussed at section 4.1 of the Ad Hoc Group Report:

"Recommendation 1 (addressing the definition of timely)

The IPR ad hoc group **noted** that there should be no further definition of "timely" since this would constitute a "change to the policy".

However, the IPR ad hoc group **recommends** that ETSI Members should implement mechanisms to improve timeliness and deal as far as possible with the uncertainties. Such mechanisms could include guidance on best practice to ensure timeliness."

“Recommendation 2 (addressing the improvement of timeliness of essential IPR disclosures)

The IPR ad hoc group **recommends** that, in order to set down the basis for early disclosure by ETSI Members of their alleged-essential IPRs, ETSI Members having IPR portfolios should improve their internal IPR co-ordination processes to ensure, as far as possible, that their standards body attendees are aware of any alleged-essential IPR the company may have (related to the on-going work on a particular ETSI Standard or Technical Specification), that they understand their obligations, and that they know how to discharge them.”

“Recommendation 3 (addressing the improvement of timeliness of essential IPR disclosures)

The IPR ad hoc group **recommends** a review of the ETSI Seminar material on Members’ obligations under the IPR policy with respect to Recommendation 2. This will help to ensure that new standards body attendees understand their obligations, and know how to discharge them.”

“Recommendation 4 (addressing the improvement of timeliness of essential IPR disclosures)

The IPR ad hoc group **recommends** that the TB Chairman's Guide on IPR should encourage Members to use general IPR undertakings/declarations and then provide or refine detailed IPR disclosures as more information becomes available.”

“Recommendation 5 (addressing the improvement of timeliness of essential IPR disclosures)

The IPR ad hoc group **recommends** that ETSI should co-operate with other SDOs on improving the timeliness of disclosures relating to essential or potentially essential IPRs.”

“Recommendation 6 (dealing with the uncertainty of timeliness)

The IPR ad hoc group **recommends** that the TB Chairman's Guide on IPR should include a note that those Members developing products based on standards where there may be essential IPRs, but there is uncertainty, have mechanisms they can use to minimize their risk. As a non-exclusive example, a Member might wish to put in place financial contingency, based on their assessment of “reasonable” (a separate issue in this discussion) against the possibility that further/additional license fees might become payable.”

478. Section 4.2 of the Ad Hoc Group Report discussed the issues arising from late IPR declarations:

“4.2 Late IPR Information Statement and Licensing Undertaking/Declaration

Generally, there is only a problem with late IPR declarations if the patent is not available at all for licensing, or is not available on "Fair, Reasonable and Non-Discriminatory (FRAND)" terms.

Mechanisms for making late declarations to ETSI need to be clarified (Note: At present declarations – late or otherwise – can be made to the ETSI Secretariat at any time). Time limits (3 / 6 months) also need to be considered.

ETSI Members dissatisfied with the consequences of other people’s late IPR declarations can and should have the right to appeal to the GA – e.g. to have the contents of the relevant standard / specification changed.

There is a need to work closely with other SDOs to look more carefully at the procedures (if any) for identifying and declaring any relevant essential IPRs when their text is being referenced / copied into ETSI standards and specifications.”

479. This supports Optis’ submission that there was not seen to be a problem with “late” declaration if FRAND obligations are in place and fulfilled.
480. Recommendations 7 and 9 then proposed the following amendments in respect of these issues:

“Recommendation 7 (Identifying where ETSI has a problem arising from "late disclosures" in IPRs)

The IPR ad hoc group recommends that the Chairman's (or Delegate's) Guide on IPR should include a note that:

"...the main problems for ETSI as a standards body which arise from "late disclosures" include:

- Licenses for the Patents disclosed late and are not available at all, or,
- Licenses for the Patents disclosed late are available, but are not on Fair, Reasonable and Non-Discriminatory (FRAND) terms, i.e. the company is unwilling to make a ‘FRAND’ undertaking/declaration.

If the above problems cannot be satisfactorily resolved, then ETSI has to change the standard, which in some extreme cases could even include the need to start again with the development of that standard....”

“Recommendation 9 (concerning the update of Standard or Technical Specification)

The IPR ad hoc group recommends that Published Standards or Technical Specifications should not be redrafted because a change on the essentiality of an IPR arises unless the required undertaking/declaration has not been provided within the three month period foreseen under section 6.1 of the IPR Policy, or has been refused. Any IPR changes should be entered into the ETSI IPR Database, showing the date of the entry.”

481. Section 4.12 discussed “out of scope issues” (that is, issues which were discussed but upon which no consensus was reached):

“4.12 Out of Scope issues

The GA is invited to note the following issues which were discussed, but upon which no consensus was reached. Furthermore, they were ruled out-of-scope:

- The requirement that ETSI Members should grant licenses on a royalty free basis when it is proven that the IPR information statement and licensing undertaking/declaration were intentionally delayed.
- The proposal to recognise the value of technical contributions from ETSI Members that have freely given their expertise and technology to develop the Standards or Technical Specifications when negotiating related IPR licenses.

Any Member interested in one of these issues is free to submit appropriate contributions to the General Assembly.”

482. Thus, a specific sanction for intentional lateness was ruled out of scope.
483. As well as the provisions of the Ad Hoc Group Report, Optis relied on details of the discussions that went on. To a considerable extent I thought the detail that Optis went into on this was unjustified, but it is important that, as Mr Rodermund accepted, there was extensive discussion of the fact that many companies were declaring well after the freeze date. It is also notable that there were strong statements of general agreement that “late” declarations were not a problem provided FRAND licences were available; of course this sentiment was also reflected in the Ad Hoc Group Report in section 4.1.

The 2004 IPR Guide

484. The 2004 ETSI IPR Guide was published in September 2004 (the “**ETSI IPR Guide**”). The ETSI IPR Guide had been proposed in the Ad Hoc Group Report,

and its content is in large part similar to the content of that report. For myself I do not think it took matters much further.

485. Article 1.1 lay down the purpose of the ETSI IPR Policy:

“1.1 What is the Purpose of the IPR Policy?”

The purpose of the ETSI IPR Policy is to facilitate the standards making process within ETSI. In complying with the Policy the Technical Bodies should not become involved in legal discussion on IPR matters. The main characteristics of the Policy can be simplified as follows:

- Members are fully entitled to hold and benefit from any IPRs which they may own, including the right to refuse the granting of licenses.
- Standards and Technical Specifications shall be based on solutions which best meet the technical objectives of ETSI.
- In achieving this objective, the ETSI IPR Policy seeks a balance between the needs of standardization for public use in the field of telecommunications and the rights of the owners of IPRs.
- The IPR Policy seeks to reduce the risk that investment in the preparation, adoption and application of standards could be wasted as a result of an Essential IPR for a standard or technical specification being unavailable.
- Therefore, the knowledge of the existence of Essential IPRs is required as early as possible within the standards making process, especially in the case where licenses are not available under fair, reasonable and non-discriminatory (FRAND) terms and conditions.

The ETSI IPR Policy defines the rights and obligations for ETSI as an Institute, for its Members and for the Secretariat.

The Policy is intended to ensure that IPRs are identified in sufficient time to avoid wasting effort on the elaboration of a Deliverable which could subsequently be blocked by an Essential IPR.”

486. This further emphasises that it was fully expected that ETSI Standards would involve the use of patented inventions and that members were entitled to benefit from holding such patents.

487. Article 1.4 set out the rights and obligations deriving from the ETSI IPR Policy, for ETSI itself, the members, the secretariat, and third parties:

	Obligations	Rights
Institute	<ul style="list-style-type: none"> to inform users of standards about Essential IPRs declared and ensure that this information is publicly available (<i>clause 7</i>). to perform IPR searches if the EC and/or EFTA so require and reasonable expenses are met (<i>clause 6.2</i>). to grant licenses on ETSI-owned IPRs (other than copyright) on fair, reasonable and non-discriminatory terms and conditions to third parties, free of charge to ETSI Members (<i>clause 9.3</i>). to respect confidential information within a Technical Body until publication of the relevant Deliverable. to include the information in a standard (<i>clause 10</i>). 	
Members	<ul style="list-style-type: none"> to inform ETSI about their own, and other people's Essential IPRs (<i>clause 4.1</i>). owners of Essential IPRs are requested to undertake to grant licenses on fair, reasonable and non-discriminatory terms and conditions (<i>clause 6.1</i>). owners of Essential IPRs who refuse to grant license when no alternative is available, are requested to reconsider their position and provide the Director-General with a justification (<i>clause 8.1</i>). to abstain from claiming copyright on standards documentation (text, graphics etc., of the standard itself) on behalf of the member itself and its employees (<i>clause 9.1</i>). 	<ul style="list-style-type: none"> no obligation to conduct IPR searches (<i>clause 4.2</i>). to refuse the inclusion of own IPRs in standards (<i>clauses 8.1 and 8.2</i>). to be granted licenses on fair, reasonable and non-discriminatory terms and conditions in respect of a standard (<i>clause 6.1</i>). to make copies of standards documentation (<i>clause 11</i>) free of charge.. to use IPRs owned by ETSI free of charge (<i>clause 9.3</i>). to have confidential information within a Technical Body respected until publication of the relevant Deliverable (<i>clause 10</i>).
Secretariat	<ul style="list-style-type: none"> the Director-General to contact owners of Essential IPRs having refused to grant licenses on behalf of ETSI (<i>clauses 8.1 and 8.2</i>). the Director-General to request the owner of an Essential IPR to give within three months an undertaking in writing that it is prepared to grant licenses (<i>clause 6.1</i>). 	
Third Parties	<ul style="list-style-type: none"> the ETSI IPR Policy is only binding on ETSI Members. Third parties do not have any legal OBLIGATIONS under the Policy. 	<ul style="list-style-type: none"> Third parties have certain RIGHTS under the ETSI IPR Policy either as owners of Essential IPRs or as users of ETSI standards or documentation:
	<ul style="list-style-type: none"> when ETSI is informed that an IPR belonging to a non-Member could be essential for a standard, the non-Member owner is also requested to undertake to grant licenses on fair, reasonable and non-discriminatory terms and conditions (<i>clause 6.1</i>). 	<ul style="list-style-type: none"> to refuse the inclusion of their own Essential IPRs in ETSI Deliverables (<i>clause 8.1 and 8.2</i>). To be granted licenses on fair, reasonable and non-discriminatory terms and conditions in respect of a standard at least to manufacture, sell, lease, repair, use and operate, (<i>clause 6.1</i>) to be granted licenses for ETSI owned IPRs (other than copyright in the standard documentation) (<i>clause 9.3</i>) on fair, reasonable and non-discriminatory terms and conditions. to have confidential information within a Technical Body respected until publication of the relevant Deliverable (<i>clause 10</i>).

488. The first part of Article 2 set out the importance of timely disclosures of essential IPRs:

“2. Importance of timely disclosure of Essential IPRs

The main problems for ETSI as a standards body which may arise from "late disclosures" include:

- Licenses for Patents which have been disclosed late and are not available at all, or,
- Licenses for Patents which have been disclosed late and which are available, but not on Fair, Reasonable and Non-Discriminatory (FRAND) terms, i.e. the company is unwilling to make a ‘FRAND’ undertaking/licensing declaration.

If the above problems cannot be satisfactorily resolved, then ETSI has to change the standard, which in some extreme cases could even include the need to start again with the development of that standard.

NOTE 1: Definitions for “Timeliness” or “Timely” cannot be agreed because such definitions would constitute a "change to the Policy".

NOTE 2: The following description of Intentional Delay has been noted:

"Intentional Delay" has arisen when it can be demonstrated that an ETSI Member has deliberately withheld IPR disclosures significantly beyond what would be expected from normal considerations of "Timeliness".

This description of ‘Intentional Delay’ should be interpreted in a way that is consistent with the current ETSI IPR Policy. In complying with the requirements of timeliness under section 4.1 of the IPR Policy, Members are recommended to make IPR disclosures at the earliest possible time following their becoming aware of IPRs which may be Essential.

NOTE 3: "Intentional Delay", where proven, should be treated as a breach of the IPR Policy (clause 14 of the ETSI IPR Policy) and can be sanctioned by the General Assembly.”

489. Article 2.1.1 was about responding to Calls for IPRs:

“2.1.1 Responding to Calls for IPRs performed in Technical Body meetings

Members participating in Technical Bodies should respond at the earliest possible time to the Call for IPRs performed by Technical Body Chairmen at the beginning of each meeting, based on the working knowledge of their participants.

Furthermore, the call for IPRs acts as a reminder of the Member’s obligations under the IPR Policy and is performed **to foster the timely disclosure of Essential IPRs.**

Members having IPR portfolios should improve their internal IPR co-operation processes **to ensure, as far as possible, that their participants in Technical Bodies are aware of any alleged-essential IPR the company may have (related to the on-going work on a particular ETSI Standard or Technical Specification), that they understand their obligations, and that they know how to discharge them.**

Members are encouraged to make general IPR undertakings/licensing declarations that they will make licences available for all their IPRs under FRAND terms and conditions related to a specific standardisation area and then, **as soon as feasible**, provide (or refine) detailed disclosures. This process reduces the risk of the standards making process being blocked due to IPR constraints.”

490. Article 2.3.3 was about when and how Calls for IPRs should be made (I have described above what these were):

“2.3.3 When and How?

A formal call for IPR disclosures shall be made by the Chairman at the beginning of each meeting.

The formal call for IPR disclosures needs to be made by the Chairman orally or in writing according to the example given below. Members need to be reminded that the recommended form for the notification of essential IPRs and licensing declaration are available on-line and attached in Annex B.

Example of a formal call for IPRs

The attention of the members of this Technical Body is drawn to the fact that ETSI Members shall use reasonable endeavours under clause 4.1 of the ETSI IPR Policy ... to inform ETSI of Essential IPRs in a timely fashion. This section covers the obligation to notify its own IPRs but also other companies’ IPRs.

The members take note that they are hereby invited:

- to investigate in their company whether their company does own IPRs which are, or are likely to become Essential in respect of the work of the Technical Body.
- to notify to the Chairman or to the ETSI Director-General all potential IPRs that their company may own, by means of the IPR Information Statement and the Licensing Declaration

forms that they can obtain from the ETSI Technical Officer or http://www.etsi.org/legal/IPR_database/IPRforms-V4.doc."

Members are encouraged to make general IPR undertakings/declarations that they will make licenses available for all their IPRs under FRAND terms and conditions related to a specific standardization area and then, as soon as feasible, provide (or refine) detailed disclosures.

During the meeting a short reminder call for IPR disclosures should be made:

- on formal submission of a technical solution;
- on completion of the first stable draft of the standard;
- on working group approval of a draft standard;
- on TB approval of a draft standard.

E.g., this may consist of the following sentence **‘May I remind Members of their obligations to use reasonable endeavours to disclose any Essential IPR [related to this issue] in a timely fashion’**”.

The Technical Body Chairmen should note and should make their attendees aware that disclosure of Essential or potentially Essential IPRs should be made at the earliest possible stage within the above list. Knowing who has contributed to the development of a standard may help identify IPRs Essential to that standard.

If it becomes apparent that an IPR declaration/licensing undertaking is unlikely to be provided, the Technical Body Chairman should inform the Legal Advisor in the Secretariat, who will take the necessary action.

Ultimately, it may be necessary for the Secretariat to invoke clause 8.1 of the Policy, which could require all work on the standard to stop. In any case, the party owning the IPR is allowed three months consideration time after the Technical Body has examined the matter and the Director-General has invited the IPR owner to reconsider its refusal to grant a license. Chairmen should use their judgment (in consultation with the Secretariat) as to whether or not the Technical Body should suspend work on the standard until the matter has been resolved.”

491. Article 2.4.4 concerned changing ETSI “Deliverables” in the light of IPRs if that became necessary:

“2.4.4 Redrafting of ETSI Deliverables

Published Standards or Technical Specifications should not be redrafted because a change on the essentiality of an IPR arises unless the required undertaking/licensing declaration has not been provided within the three month period foreseen under clause 6.1 of the IPR Policy, or has been refused. Any IPR changes should be entered into the ETSI IPR Database by the Secretariat, showing the date of the entry.”

DG Comp's proposed changes

492. In January 2005, DG Comp raised some concerns that it had with the ETSI IPR Policy. DG Comp proposed changes to clause 4.1 of the ETSI IPR Policy as follows:

“4.1 Each MEMBER shall use its reasonable endeavours to ~~timely~~ inform ETSI of ESSENTIAL IPRs ~~it becomes aware of during the development of a STANDARD or TECHNICAL SPECIFICATION~~. In particular, a MEMBER submitting a technical proposal for a STANDARD or TECHNICAL SPECIFICATION shall, on a bona fide basis, draw the attention of ETSI to any of that MEMBER's IPR which might be ESSENTIAL if that proposal is adopted.”

493. In its letter proposing those changes, the DG Comp justified the request as follows:

“In the first instance, the word “timely” has been removed. This was a continuing source of problems because as ETSI itself has confirmed, in the context of the timing of essential IPR disclosures, there was no precise definition of what “timely” meant, and therefore considerable latitude in interpretation, with all the attendant risks, remained.

As a result, secondly, “timely” has been replaced by the phrase “during the development of a STANDARD or TECHNICAL SPECIFICATION”. This phrase, in conjunction with the existing first clause of Article 4.1, therefore simply makes clear that each ETSI member shall use “its reasonable endeavours” to identify essential IPRs while a standard is being developed. This leaves open the possibility that for genuinely innocent or acceptable reasons (e.g. subsequent issue of a patent in the related area, or no reasonable way that a member could have known about its IPR while the standard was being developed), in certain circumstances, it may be the case that essential IPRs come to light after a standard has been agreed. These circumstances should obviously be distinguished from those where a member engages in a “patent ambush”, and intentionally conceals the existence of essential IPR while a standard is being developed in order to unfairly capture that standard and hence illegitimately exclude potential competing alternatives.

Finally, the phrase “it becomes aware of” has been deleted. This is because we would at least expect a member in a standard-setting process to have a general awareness of the scope of its IPR rights in that area, and therefore where necessary, take reasonable steps to identify these IPR. This is indeed consistent with the notion of members being invited by the meeting Chairman to identify IPR at the beginning of each relevant meeting. I should stress that we would not expect members to engage in patent searches in this respect.

Were ETSI to agree to these changes (which themselves reflect the practice of other major standard-setting bodies around the world), I believe that ETSI's general IPR framework [including ETSI's Guide on IPRs] would address the concerns that we have previously identified ...”

494. Discussions within ETSI resulted in a response to this proposal, and there were also ongoing negotiations between ETSI and DG Comp. Ultimately, DG Comp indicated to ETSI that if an agreement on the revised wording of clause 4.1 of the ETSI IPR Policy was not reached by 27 May 2005, the European Commission would consider whether it should review ETSI's negative clearance under Article 81(1).
495. Clause 4.1 of the ETSI IPR Policy was ultimately amended in November 2005 as below:

“4.1 Subject to Article 4.2 below, eEach MEMBER shall use its reasonable endeavours, in particular during the development of a STANDARD or TECHNICAL SPECIFICATION where it participates, to ~~timely~~ inform ETSI of ESSENTIAL IPRs in a timely fashion ~~it becomes aware of~~. In particular, a MEMBER submitting a technical proposal for a STANDARD or TECHNICAL SPECIFICATION shall, on a bona fide basis, draw the attention of ETSI to any of that MEMBER's IPR which might be ESSENTIAL if that proposal is adopted.

4.2 The obligations pursuant to Clause 4.1 above do however not imply any obligation on MEMBERS to conduct IPR searches.”

496. Alongside this amendment to clause 4.1 of the ETSI IPR Policy, a revised version of the ETSI IPR Guide was published. A new section 4.5 was included in the revised version of the ETSI IPR Guide, which was written by DG Comp. Section 4.5 provides:

“4.5 Rationale and clarifying texts for the changes in Article 4.1 of the ETSI IPR Policy

A revised version of the Article 4.1 of the ETSI IPR Policy was adopted by the 46th General Assembly on November 2005. This revision was induced by the EC DG COMPETITION in its concern to generate a general awareness of the risk of “patent ambush” situation in the standard making process.”

497. Optis characterised the change to Clause 4.1 as being merely the moving of the “timely” requirement. That is an understatement, because the words “in particular ... participates” were added and provide a focus on the pre-freeze time period. Both ETSI and the Commission thought they had achieved something, but overall I think it is clear from new clause 4.5 of the Guide that what the Commission achieved was an added emphasis for avoiding what it called “patent ambush”, while there was no reason for ETSI to regard itself as having actually

changed the requirements of Clause 4.1. I certainly do not think there was ever a true meeting of minds, because ETSI's clear position prior to 2005 was that patents covering the standard were an inevitable consequence of choosing the best technical solutions and did not cause a problem so long as an effective FRAND regime was in place. So it would not have regarded "unfairly captur[ing] the standard" or "illegitimately exclud[ing] potential competing alternatives", which the Commission had identified as the vices of patent ambush for these purposes, as being risks.

498. Optis pointed out that no change to the second sentence of clause 4.1 was asked for, or made. This is true as a matter of where the textual change was made, but since the second sentence begins "In particular ..." it would be possible for a change to the first sentence to carry through. In any event, I think that is excessively detailed and the more important point is the one to which I have already referred, which is that ETSI regarded itself as having fended off any substantive change.

Conduct and states of mind of Ericsson and of Apple

499. The facts as to the Ericsson TDoc, the Patent, and the associated declaration are not in dispute, as I have said. However, Apple made various assertions about Ericsson's state of mind, and Optis has retaliated by way of the clean hands point, to which I have referred above.
500. Apple asserted in intemperate language that Ericsson's conduct amounted to "concealing the existence of a potentially essential patent"; that it was "deliberate and egregious rule-breaking"; that Ericsson "flouted" the ETSI IPR Policy; that Ericsson "deliberately concealed" the application leading to the Patent; that Ericsson's conduct was "flagrant".
501. Optis' response was more measured and was simply to the effect that Apple's conduct as to the timing of declarations was essentially the same as Ericsson's (it went a bit further and said that Apple declared after the freeze date even more than Ericsson, and that Ericsson was better than average, but these are minor details and the big picture was that they both followed the general pattern that I have described above).
502. Objectively speaking, I have the materials to conclude that both Ericsson and Apple followed the typical pattern of ETSI declarants. It was therefore odd to hear Apple castigate Ericsson in the terms that it did. Apple sought to evade confronting this by saying that its conduct was not in issue, but I found this unconvincing. Apple's conduct was in issue on the clean hands point, at least.
503. As to their subjective states of mind, the evidence is limited because Apple did not call any witness from its own business, and Optis did not call any witness from Ericsson. I do not have direct evidence about their beliefs as to whether what they did in making declarations complied with the ETSI IPR Policy. I also have no evidence about the state of mind of Apple or Ericsson at the time of the presentation of the Ericsson TDoc.

504. Apple in particular invited me to draw adverse inferences from Optis' failure to call fact evidence from Ericsson. The evidence that Optis could have called someone from Ericsson is not all that strong; Ericsson retains a financial interest in the Patent but that does not necessarily mean that it has committed to provide evidence for these proceedings.
505. But in any event, the inherent probabilities are such that Apple has no basis to assert that Ericsson committed any act of deliberate concealment, or deliberately broke Clause 4.1. Since I conclude below that Ericsson did not breach Clause 4.1 at all, there is no starting point to consider whether there was a deliberate breach, but the surrounding circumstances, including the very high prevalence of declarations after the freeze date and ETSI's own attitude, are such that the inherent probability that any particular declarant thought it was in breach is very low. There is no basis for inferring otherwise in the case of Ericsson and there was no need for Optis to call a witness to rebut something so inherently unlikely. I also see no basis for Ericsson to have thought that it was concealing anything when it submitted the Ericsson TDoc shortly after filing the Ericsson US Provisional. It was following common practice.
506. Apple probably could have called evidence. It might well have revealed that Apple did not review the IP status of any TDocs and never used any such analysis to prepare submissions at WGs. But that is, anyway, what I find was the general practice. It is possible that an Apple witness would also have agreed that a proposal such as that made by the Ericsson TDoc in WG2 would have been seen as likely to be covered by a patent application. This too was obvious and was, I have found, the case. In short, an Apple witness might well have accepted that there was no specific reliance by, or detriment to, Apple itself, and that Apple was not itself subject to any assurance. But that is not Apple's case.
507. Evidence from Apple might also have revealed whether Apple thought it was complying with Clause 4.1. The strong likelihood is that Apple, as a large and reputable company to whom IPR is of crucial importance (like Ericsson), considered that it was in compliance with Clause 4.1. I strongly suspect that the reasons for Apple not calling a witness included a tactical desire not to have to acknowledge that. But it does not matter, or help my decision making.
508. Thus, the whole argument about drawing inferences was irrelevant and unhelpful.

MEANING OF CLAUSE 4.1 – ASSESSMENT

509. Having now identified the principles of French law and the facts, I turn to consider whether Clause 4.1 requires what Apple says, and thus whether Ericsson was in breach of it.
510. As I have already said, I think it obvious that Clause 4.1 is not clear and precise. It is therefore open to interpretation under French law.
511. I think that it is possible to determine ETSI's subjective intention in the sense identified above. It is not possible to determine members' subjective intentions

in a meaningful way. So in general I have to have regard to objective factors for that purpose.

512. I note that Apple agrees that the first sentence of Clause 4.1 is an obligation of means. This seems obvious to me given the use of the concepts of “reasonable endeavours” and “timely fashion”.
513. Apple contends, however, that the second sentence is an obligation of result. It also contends that the first sentence imposes an obligation of means to declare by the stage 3 freeze date, and the second sentence imposes an obligation of result to declare at around the time of submission of a relevant TDoc (essentially, one intended to be covered by a patent application).
514. Apple’s submissions on the wording of clause 4.1. have some force; in particular “during the development” and “if that proposal is adopted” do have the connotation of the period before the freeze date. It is possible to read the second sentence the way Apple argues if one does so at a purely textual level and without context. But there are serious problems with Apple’s approach:
- i) I think it makes little sense to interpret the first sentence as an obligation of means and the second as an obligation of result. No coherent reason for that was given.
 - ii) There seems no reason to think that the two sentences are setting two different time limits.
 - iii) Most significantly, I think, there is no reason to split the two sentences apart and analyse them separately in the first place. The second sentence begins “In particular ...” and I do not see how that could reasonably be seen to mark a segue to an obligation of a quite different nature (of result) with a different time limit.
 - iv) Defining the first sentence in the way that Apple seeks cannot help it anyway, since, as Counsel for Optis pointed out, if Ericsson were permitted to declare at any time up until the freeze date and did so towards or at the end of that period there would be no way for WG members to take such a declaration into account.
515. Overall, it makes much more sense to read “reasonable endeavours”, “timely fashion” and “bona fide” as together implying an obligation of means in relation to the Clause as a whole.
516. So far, and partly in order to dispose of the means/result question, I have mainly considered the words of the Clause. However, it would be a trap, inconsistent with French law, to make that a fixed starting point for the consideration of what the Clause requires. The overall exercise is one of identifying the parties’ intentions. Apple’s submissions were far too heavily focused on the wording, in particular in the submission that the words used must themselves form the best evidence of the parties’ intention. That is not French law.

517. In my view, the historical context and development of the ETSI IPR Policy, taken with the behaviour of declarants, is very important. They show a move away from the relatively hard edged rule in the 1993 Interim IPR Policy to a more flexible standard in the 1994 Interim IPR Policy, as reviewed in 2005.
518. In 2005, ETSI gave thought to the specific obligation I am now considering, and declined to make the full changes sought by DG Comp; but it did make some change. At the time and for some years before, the vast majority of declarations had been after the freeze date. But ETSI clearly did not regard that as a problem in itself, as long as there was a functioning mechanism for making sure FRAND declarations were given and respected.
519. Moreover, at the time ETSI's own mechanisms for making declarations were not set up to ensure that declarations, even if made very early, would be reflected in the IPR database in time for consideration at WGs: until 2007 it was only possible to declare on paper, with the long reflection times identified above. It would make no sense to impose a strict requirement to declare at the same time as a TDoc in a system with such a built-in delay.
520. A broader point is that it could not have been expected that ETSI's mechanisms (including forms) for declaration would stand still; they had changed in the past and were likely to do so again. It is a much more natural assessment of Clause 4.1 that it imposed a flexible obligation to be assessed in the light of circumstances of a particular situation and in the context of whatever ETSI's procedures were at the time.
521. The fact that the practice of declaration timing (almost all after the freeze date) continued after 2005 is also significant. It was not just a few rogue declarants but the great majority of them, and is important that ETSI had not made a statement of change of policy or approach when the 2005 change to clause 4.1 was made, or, thereafter, given any guidance that what it had hoped for was not materialising.
522. A further important factor, clear from the historical development and surrounding discussions, is ETSI's general policy goals in relation to clause 4.1. Its recognition that "late" declaration was not a problem so long as the FRAND regime worked militates against a hard-edged requirement of the kind that Apple asserts, and the goal of declarations being made for the purposes of licensing negotiations, which clearly was important, also did not require a hard-edged rule.
523. I also find some significance in the fact that if ETSI had thought that declaration with submission of a TDoc was mandatory it could easily have ensured that at any time by changing its forms, in particular by putting a check-box on the TDoc submission form as to whether there was potentially relevant IP (a proposal that was in fact made at one point, but not adopted).
524. Optis also relied on the fact that many declarants made their declarations in batches, from time to time. I think this is also a factor, but a minor one. It was really for their own convenience. But it was a known approach, not objected to by ETSI, and that supports its reasonableness.

Unpublished patent applications

525. There was a dispute between the parties as to whether unpublished patent applications fell within clause 4.1, in particular the second sentence with its expression “IPR which might be ESSENTIAL if that proposal is adopted”.
526. It is somewhat artificial to interpret this separately from the main dispute. If those words had been appended to an obligation which explicitly required declaration at the same time as a TDoc the situation might be different and I would have tended to agree with Apple, but seen in the broader context that I have to consider, I think that the fact that an application was unpublished so that its scope could not usefully be identified would be a significant factor in determining reasonable endeavours, timeliness, and bona fides. I accept Optis’ point that at the moment of presenting a TDoc the scope both of the standard and of any ultimate patent flowing from an application would be uncertain, and it would be a matter of judgment when the possibility of essentiality was high enough to declare. Indiscriminate declaration at the time of submitting a TDoc would lead to over-declaration, which I am sure both ETSI and its members knew could be a problem.

Conclusion on Clause 4.1

527. I reject Apple’s contentions as to the meaning of Clause 4.1, and therefore its case that Ericsson was in breach, which depended on there being a definite time limit for each sentence of the Clause. I have also rejected Apple’s approach to Clause 4.1 generally.
528. I am conscious that I have not included in this judgment any definitive statement as to what Clause 4.1 requires in all situations. I do not think that a French Court would do so. It is enough to say that the Clause sets a flexible standard which depends on the circumstances. For the purposes of this judgment, all I need do is reject Apple’s contention that Ericsson was in breach.
529. In that connection, and in case I am wrong on Clause 4.1, I record, at the risk of repeating myself, that Ericsson’s approach was well within the range of what ETSI declarants generally did, and it was reasonable, objectively speaking, for Ericsson to think that it was complying with the Clause.

ANALYSIS OF APPLE’S PRIMARY “NO-IPR” CASE

530. Mindful that there are no watertight compartments and that I must make an overall assessment, I will nonetheless consider assurance separately, before moving on to reliance and detriment, which I think are intertwined closely in the circumstances of this case.

Assurance

531. Given my findings of fact, no member of the RAN WG2 could reasonably have been under the impression that the Ericsson TDoc was IPR-free. There is no evidence that any of them in fact was under such an impression and my overall

assessment is that I can confidently, positively conclude that none in fact was. This in itself is enough to dispose of any argument by Apple in relation to assurance.

532. Further, if any of them was under such an impression, there is no reason why Ericsson could or should have been aware of it. This is a very hypothetical alternative finding, but it would be a further reason to reject any assurance based on Ericsson's acquiescence in a mistaken state of mind of WG members.
533. My findings of fact also mean that any argument that Ericsson made a representation by its silence must fail. Ericsson's silence would, objectively, be understood to be entirely consistent with its having filed a patent application, but not yet having declared it (or alternatively having declared it, but it still being in the "reflection" period when it had not yet been published by ETSI). The surrounding circumstances would, again objectively, be seen to make it likely that Ericsson had filed a patent application. I reject any contention that Ericsson made, by its silence, a representation of "No-IPR".
534. I have found that Ericsson was not in breach of clause 4.1. But even if I had been wrong about that, I do not think it would mean that there was any relevant assurance. At the time and for years previously, the majority of declarants did not declare before the stage 3 freeze date, and the WG and ETSI members generally knew as much. That is what matters from a factual point of view. Even if I had concluded, in the year 2021, that those declarants were all in fact in breach of clause 4.1, that would not affect what the state of mind of WG members was in 2008, or 2010.

Reliance and detriment

535. Since my findings of fact are that the WGs did not assess TDocs by reference to whether they were, or were likely, to be covered by IPR, there could be no reliance. Even if Ericsson had positively said that it had IPR over the Ericsson TDoc, the RAN WG2 would have acted in just the same way and the Ericsson TDoc would have been adopted, because it was the best technical solution. Any assurance about IPR would have been irrelevant.
536. Since IPR was just not considered by the WGs, it is again very hypothetical to consider whether there was any detriment. It will be recalled that Apple does not assert that some other non-patented solution would have been chosen, only that there was a chance that it might. I consider that chance to be nil.
537. Further, even if the WG had considered patents, there was on my findings of fact, no technically equivalent solution, so given that the key consideration was choosing the best technical solution, the Ericsson TDoc solution would have been chosen in any event.
538. Therefore, there was no reliance and no detriment.

Unconscionability

539. This is a cross-check if the Court reaches a provisional conclusion that the three key elements are present, so it does not arise.

ANALYSIS OF APPLE'S SECONDARY CASE

540. Apple's secondary case was that there was a loss of the benefit of the process that the ETSI rules, specifically Clause 4.1, should have ensured.

541. I think it is helpful to try to articulate the hypothesis on which this would arise. It would not arise if Apple succeeded on its main case of proprietary estoppel, since then it would not be necessary, because it is a fall back. It also would not arise if there were no breach of Clause 4.1 of the ETSI IPR Policy, since it depends on the proposition of deprivation of what Clause 4.1 ought to have ensured. So it seems to me that I am asked to assume that Apple's primary case for proprietary estoppel must have failed, but that there was a breach of Clause 4.1. I must also bear in mind that the argument remains one of proprietary estoppel, not breach of Clause 4.1 as such.

542. All that being so, I cannot see how Apple's secondary case is coherent at all. If a proprietary estoppel is not made out then it is not made out. A bare breach of a contractual obligation owed to someone else is no substitute, especially if it occasioned no loss.

543. I think it is possible that the secondary case may in some way have been intended to try to put in place some lesser kind of detriment (loss of process versus loss of a chance of the standard actually being different) while retaining the same arguments about assurance and reliance, but this does not make sense either, when the assurance asserted was that there was no relevant IPR. In any event, if in some way a bare breach of clause 4.1 had been made out, but which had not even a possible effect on the standard then I would have held that it was not a real or significant detriment as is required for proprietary estoppel.

544. Thus the secondary argument also fails.

REMEDY

545. For obvious reasons this does not arise, but I will say that if in some way Apple's secondary argument had succeeded and there was a proprietary estoppel based on a bare breach of Clause 4.1 with no actual or potential impact on the relevant standard, then the relief Apple seeks, that Optis cannot enforce the Patent, alternatively cannot obtain an injunction, would be plainly disproportionate and I would have refused it.

TRANSFER OF THE BENEFIT AND OF THE BURDEN

546. Thus far I have been looking at matters, as the parties did, as between Ericsson and ETSI and its members generally. As I said at the outset of this part of my

judgment, they treated it as a separate question whether Apple, as a non-member of the RAN WG2, and without showing that it was individually or directly affected in any way by the assurance asserted, could benefit from any estoppel that might arise.

547. I have rejected Apple's case that there was a proprietary estoppel; I have found against it on the facts as to assurance, reliance and detriment.
548. That being so, Apple's defence fails and it is not necessary for me to decide issues of benefit and burden. Given that the decisions on proprietary estoppel at the highest level, to which I have referred above, emphasise the very flexible and fact-dependent nature of the doctrine, I think it would be unwise of me to try to state principles or rules about how and when the benefit and burden of a proprietary estoppel might affect third parties, in the abstract, when the points do not arise.
549. I will limit myself, therefore, to making any additional findings of fact that appear necessary.

“Transfer” of the benefit

550. I have put the word transfer in inverted commas in this heading because that is the label Optis used, but it is not the way that Apple put its case, as I understand it. It is not Apple's case that a proprietary estoppel arose in favour of one entity or group of entities and then was by a separate act transferred to Apple.
551. Instead, it is Apple's case that the estoppel arose in favour of all implementers of the relevant standard, and that ETSI and the WGs were acting for the benefit of potential future users of the standard (at one point Apple's pleading asserted that there was in effect an agency).
552. In case my decisions on the existence of an estoppel are overturned on appeal, I say the following about the facts:
- i) There is no evidence that ETSI members or Apple put their or its trust in the WG members in this way.
 - ii) There is no evidence that WG members thought they had any responsibility of this kind to other ETSI members in general or Apple in particular, although they did in fact want to reach the best technical solution.
 - iii) There is no reason to suppose that WG members would or might have the same interests as each other in relation to whether TDocs the subject of IP be adopted. Some might have been entirely happy with it, relying on the FRAND commitment where necessary.
553. Apple's case also extended to the assertion that ETSI itself was working for the benefit of members in a similar way. As to this:
- i) There is likewise no evidence that ETSI members or Apple relied on ETSI in this way, or that ETSI thought it had any such responsibility.

- ii) It is common ground that ETSI made no assessment of essentiality and exercised no control or oversight in relation to the analysis by WGs of which TDocs to accept, either technically or in relation to IP. ETSI maintained the database but did not use it.
- iii) ETSI's members' commercial interests differed and were likely to be inconsistent and it is therefore not possible to see how ETSI could have a duty to them all in this kind of respect.

Transfer of the burden

554. As to the burden of any proprietary estoppel that existed, one is truly, in the context of this case, and by contrast with the benefit, talking about a "transfer" and the question is whether the estoppel would be such that it could travel with the Patent on its assignment from Ericsson to Optis (specifically, to the Third Claimant, a member of the PanOptis Group).
555. Optis argued that any proprietary estoppel that might exist was personal and bound only Ericsson. It fortified this by saying that in substance what Apple was seeking was a non-exclusive licence under a patent, and that that was inherently non-proprietary.
556. Apple, by contrast, argued that the equity arising from a proprietary estoppel could itself be proprietary in nature and, in an appropriate case, could travel with the property concerned. It accepted, as I understood it, that that it was fact-dependent and could depend on the relief that would have been awarded in the light of any estoppel that existed.
557. I do not need to decide this and decline to do so. It was a complicated argument and it would be impractical to consider the nature of the equity arising from a proprietary estoppel when I have found, for multiple reasons, that there was none.

Bona fide purchaser for value without notice

558. I will deal with this very briefly since for multiple cumulative reasons it does not arise and does not involve any factual findings on my part. It was also only argued very briefly.
559. Optis floated the argument that even if the burden of any proprietary estoppel was such that it could travel with the Patent, it was a bona fide purchaser for value without notice and therefore not affected by the burden. Optis' opening skeleton said that application of the doctrine would depend on the evidence and so did not comment further.
560. In closing, Optis maintained this position but still said that it needed to see how Apple put the matter. It said that because Apple's case on the facts was based on inference and was not clear, it might not be appropriate to conclude that Optis had notice. I did not understand this.

561. Apple contended that the doctrine only applied where the Court had to resolve competing interests between right holders after an assignment and not in relation to the preclusive effect of a proprietary estoppel.
562. I do not need to decide on Apple's point of law since Optis accepted in its pleading that it had at least constructive notice of all the underlying facts as to the dates, declarations, ETSI policies and so on.

CONCLUSIONS

563. My conclusions are:
- i) The Patent is valid.
 - ii) No amendment is necessary.
 - iii) Had the attack over Pani succeeded, the amendments proposed would not have saved claim 1.
 - iv) Apple's estoppel/acquiescence defence fails.
564. I will hear Counsel as to the form of Order if it cannot be agreed. I direct that time for seeking permission to appeal shall not run until after the hearing on the form of Order (or the making of such Order if it is agreed).