



Neutral Citation Number: [2018] EWHC 1732 (Pat)

Case No: HP-2015-000063

IN THE HIGH COURT OF JUSTICE
BUSINESS AND PROPERTY COURTS
INTELLECTUAL PROPERTY LIST (CHANCERY DIVISION)
PATENTS COURT

Rolls Building
Fetter Lane, London, EC4A 1NL

Date: 10 July 2018

Before :

MR JUSTICE ARNOLD

Between :

KONINKLIJKE PHILIPS NV	<u>Claimant</u>
- and -	
(1) ASUSTEK COMPUTER INCORPORATION	<u>Defendants</u>
(2) ASUSTEK (UK) LIMITED	
(3) ASUS TECHNOLOGY PTE. LTD	
(4) HTC CORPORATION	
(5) HTC EUROPE CO. LTD	

Mark Vanhegan QC and Adam Gamsa (instructed by **Bristows LLP**) for the **Claimant**
Thomas Hinchliffe QC and Jeremy Heald (instructed by **Taylor Wessing LLP**) for the **ASUS**
Defendants and (instructed by **Hogan Lovells International LLP**) for the **HTC Defendants**

Hearing dates: 19-22, 27 June 2018

Approved Judgment

I direct that pursuant to CPR PD 39A para 6.1 no official shorthand note shall be taken of this Judgment and that copies of this version as handed down may be treated as authentic.

.....
MR JUSTICE ARNOLD

MR JUSTICE ARNOLD :

Contents

<i>Topic</i>	<i>Paragraphs</i>
Introduction	1-8
The witnesses	9-25
Mr Kahtava	9-12
Professor Purat	13-25
Technical background	26-123
Mobile telecommunication standards	27-33
Standard setting	34-39
Elements of a mobile telecommunications system	40-46
OSI seven layer model	47-50
Channels	51-57
Duplexing schemes	58-61
Multiple access schemes	62-65
Functions of the radio transmission chain	66-71
Noise and interference	72-74
Signal transmission and detection	75-80
Power control	81-99
Near-far problem	85-88
Slow fading	89
Multipath (fast) fading	90-93
Power control techniques	94-99
UMTS Release 5	100-123
Downlink channels	101-104
HSDPA	105-107
Power control	108-109
Pilot signals	115
Common pilots	116-120
Dedicated pilots	121-123
The Patent	124-128
The claims	129-132
Construction	133
The skilled person	134-138
Common general knowledge	139-164
Cdma2000	140-141
Uses of downlink dedicated pilot signals	142-162
Power control	142-143
Channel estimation and phase reference	144-148
Layer 1 synchronisation	149-151
Closed-loop transmit diversity	152-156
Beamforming	157-162
Backwards compatibility	163
Implementation issues	164
Nortel May and Nortel October	165-185
Nortel May	166-180
Nortel October	181-185

Obviousness over Nortel October	186-199
Difference between Nortel October and claim 1	186-187
Primary evidence	188-194
Secondary evidence	195-197
Conclusion	198
The Dutch decision	199
Conclusion	200

Introduction

1. These proceedings concern three patents owned by the Claimant (“Philips”): European Patent (UK) No. 1 440 525, European Patent (UK) No. 1 685 659 and European Patent (UK) No. 1 623 511. Philips has declared that these patents are essential to the European Telecommunications Standards Institute (ETSI) Universal Mobile Telecommunications System (UMTS) standard (“the Standard”), in particular the sections of the Standard that relate to the operation of the system known as High Speed Packet Access (HSPA).
2. The Defendants fall into two groups: the First, Second and Third Defendants (“the ASUS Defendants”) and the Fourth and Fifth Defendants (“the HTC Defendants”). Both the ASUS Defendants and the HTC Defendants sell HSPA-compatible mobile phones. Philips alleges infringement of the patents by reason of their essentiality to the relevant versions of the Standard.
3. By a consent order dated 12 April 2017 it was agreed that the technical issues relating to the patents would be tried in two separate trials: Trial A concerning the validity and essentiality of EP (UK) 1 440 525 and Trial B concerning the validity and essentiality of the other two patents. Further technical issues that have subsequently emerged will if necessary be tried in a third trial, Trial C. Issues relating to Philips’ undertaking to ETSI to grant licenses on FRAND terms will if necessary be addressed in a fourth trial, Trial D.
4. This judgment concerns the validity of European Patent (UK) No. 1 685 659 (“the Patent”) following Trial B. The Patent is entitled “A Radio Communications System, Method of Operating a Communication System, and a Mobile Station”. There is no challenge to the claimed priority date of 12 November 2003 (“the Priority Date”). At trial there was no issue as to essentiality or infringement. The Defendants advanced a common case contending that the Patent was invalid for obviousness over (in effect) a single item of prior art (two other items of prior art having been abandoned during the course of trial), namely document R1-031074, a contribution submitted to the 3GPP TSG-RAN Working Group 1 meeting number 34 in Seoul, South Korea on 6-10 October 2003 by Nortel Networks (“Nortel October”), read together with document R1-030546, a contribution submitted to the 3GPP TSG-RAN Working Group 1 meeting number 32 in Marne La Vallee, France on 19-23 May 2003 by Nortel Networks (“Nortel May”) which is cross-referenced in Nortel October.
5. Philips does not seek to maintain the validity of the Patent as granted, but only as proposed to be amended.
6. There was no dispute between the parties as to the applicable legal principles, which are well established. Accordingly, there is no need to set them out in this judgment.

7. As in Trial A, the parties filed a substantial volume of evidence and submissions, although some of the material was directed to issues which have fallen away. Again, I have taken all the relevant material into account, but I do not consider it necessary to refer to all of it in this judgment.
8. This judgment is intended to be free-standing. For convenience it repeats a certain amount of material from my judgment after Trial A, but it is based on the evidence and submissions concerning the Patent.

The witnesses

Mr Kahtava

9. Philips' expert was Jussi Kahtava. Mr Kahtava received a Master of Science degree from Tampere University of Technology, Finland in 1995, majoring in digital signal processing. He started working for Nokia (before finishing his thesis) in 1994 as a research engineer. He was involved in link layer simulations of CDMA systems, modelling the physical layer. In 1995 he supported Nokia's IS-95 standards team based in Irving, Texas. While in the US, he gained exposure to technologies that eventually formed part of cdma2000. In 1998, he moved to Japan to work as a senior design engineer for Nokia. He attended ARIB (the Japanese standards organisation developing third generation WCDMA systems) meetings as a physical layer specialist. These included harmonisation meetings with TTA (USA) and TTA (Korea) prior to the establishment of the 3GPP and 3GPP2 third generation partnership projects.
10. Mr Kahtava attended meetings of the physical layer specification group, RAN WG1, from February 1999, focussing on modulation and channel coding, power control, rate matching and compressed mode. He also edited the TS 25.222 technical specification. From 2002 to 2006 he acted as head of the Nokia delegation to RAN WG1, overseeing a team of 10 delegates and several colleagues who did not attend the meetings, but instead worked behind the scenes. He and his team actively contributed to Release 5, which included the high-speed downlink channel. He also contributed to Release 6, focussing on beamforming and multiple input multiple output (MIMO) technologies including transmit diversity and antenna verification. In 2006 he moved to lead Nokia's activity in ITU-R (ITU Radiocommunication Sector (ITU-R) is one of the three sectors (divisions or units) of the International Telecommunication Union (ITU) and is responsible for radio communication).
11. Mr Kahtava set up his own consultancy company in 2012 and works for high-profile telecoms clients, including Huawei and Qualcomm. He is named as an inventor on nine granted patents.
12. Counsel for the Defendants made no criticism of Mr Kahtava's oral evidence. Counsel submitted, however, that parts of Mr Kahtava's expert reports, and in particular his second report, were unfortunately drafted since they gave the impression that he was disagreeing with points that he in fact agreed with. Mr Kahtava accepted in cross-examination that at least two passages in his second report were misleading. Counsel for Philips submitted that Mr Kahtava had been too ready to accept these criticisms. In my view Mr Kahtava's second report could, and should, have been clearer as to the points he was accepting; but as counsel for the Defendants recognised, Mr Kahtava did clarify his position in cross-examination.

Professor Purat

13. The Defendants' expert was Professor Marcus Purat. Prof Purat obtained a first diploma degree in Electrical Engineering from the University of Applied Sciences in Bochum, Germany. He received a second diploma degree in 1991 in Electrical Engineering from Technische Universität in Berlin, Germany, where he also lectured and carried out research at the Institute for Telecommunications. He was awarded a PhD in Electrical Engineering in 1998 in the field of digital signal processing and communications.
14. Prof Purat worked as a development and systems engineer at Siemens Mobile Information & Communication in Berlin between 1997 and 2003, focussing on system testing GSM core network equipment and UMTS standardisation. During that time, he led the Siemens delegation to RAN WG1 and was involved in the drafting of UMTS Releases 99, 4, and 5, including in respect of power control, spreading and modulation, synchronisation, transmit diversity and HSDPA. In 2000, Prof Purat chaired the WG RAN1 Adhoc Group on UMTS TDD, coordinating the integration of the Chinese TD-SCDMA Standard into the 3GPP Standard.
15. Prof Purat has been a Professor at Beuth-Hochschule, University of Applied Sciences in Berlin since April 2003, where he carries out research and gives lectures in the fields of digital signal processing and communications systems. He was appointed head of the Digital Signal Processing Laboratory within the Electrical Engineering department in 2012. Prof Purat is co-author of a number of published papers and a named inventor on 17 patents.
16. Since 2004, Prof Purat has also consulted part-time for Hillebrand Consulting Engineers GmbH offering IPR-related services, such as prior art research, essentiality analyses and expert advice in litigation relating to mobile communication (GSM, UMTS, and LTE).
17. Counsel for Philips submitted that Prof Purat was not a satisfactory expert witness. Counsel advanced a number of criticisms of Prof Purat's evidence in support of this submission which require separate consideration, because they are different in nature.
18. First, counsel submitted that Prof Purat had given misleading evidence when he made a declaration for the purposes of Dutch proceedings between Philips and Sony Mobile Communications International AB ("Sony") concerning the Dutch counterpart of the Patent in 2012. Prof Purat stated in the declaration that TDoc R1-99-968 ("Nortel 99") "was discussed during the 3GPP TSG-RAN Working Group 1 meeting #6 of 13-16 July 1999 and made publicly accessible before that meeting". As Prof Purat stated in the declaration, he personally attended the meeting. What he did not say was that he did not recollect whether or not Nortel 99 was discussed at the meeting. He relied upon the minutes of the meeting, which he exhibited, which suggested that it was discussed. He also relied upon an email from Nortel dated 13 July 1999 as making Nortel 99 available for a second time. In his evidence in these proceedings, however, Prof Purat acknowledged that there is a later email from Nortel which suggests that Nortel 99 may not have been discussed at the meeting. Prof Purat explained that he had stopped searching when he found the first email, and had not found the second. I do not accept that Prof Purat thereby fell below the standards to be expected of an independent expert. Although it would have been better if a fuller search had been undertaken, I think it is

understandable that it was not. Moreover, the second email does not cast doubt on the basic point Prof Purat was making, which was that Nortel 99 had been made available to the public.

19. Secondly, counsel criticised Prof Purat for not giving any evidence on infringement. Counsel did not dispute Prof Purat's explanation that he had not been instructed to do so, but submitted that he should have done so given that he had not been instructed not to do so. I do not accept this submission. An expert witness cannot be criticised for following his instructions as to which issues he should consider. On the contrary, it is important that expert witnesses should follow such instructions. Moreover, the instructions were justified given that it turned out that there was no issue between the parties on infringement.
20. Thirdly, Prof Purat explained that, as part of his work for Sony in connection with the Dutch proceedings in 2012, he had carried out prior art searches and produced a report. Counsel criticised Prof Purat for failing to exhibit that report, but that criticism overlooks the fact that the report is probably subject to Sony's legal professional privilege. In any event, this point adds little to the fact that, as a result of his work in 2012, Prof Purat knew about both the Patent and the F-DPCH in UMTS Release 6 before being instructed in these proceedings, and thus before considering the prior art and giving his opinions on obviousness. Counsel submitted that, for a conceptual patent like this, knowing about the invention before reading the prior art gives rise to a real risk of hindsight. I agree with this.
21. Fourthly, counsel submitted that Prof Purat's evidence relating to an item of prior art which the Defendants abandoned after the end of the evidence, namely US Patent Application No. 2003/0134655 ("Qualcomm"), showed that Prof Purat had both failed to understand what was common general knowledge and had fallen into the hindsight trap. Since the Defendants abandoned reliance on Qualcomm, it is not necessary for me to deal with the substantive points, but given that they are relevant to my assessment of Prof Purat's evidence I must briefly explain why I accept these submissions.
22. It was Prof Purat's evidence that TR 25.899 v0.2.1, a study item entitled "Radio link performance enhancement", was common general knowledge. TR 25.899 includes text from Nortel May and Nortel October (as to which, see below) together with material from a third Nortel T-doc (R1-031073, "Nortel 3"). At the Priority Date, TR 25.899 had not been presented to TSG RAN for information (let alone approval), meaning that it was not yet 60% stable. The purpose of the TR was to promote evaluation of the concepts included in it. TR 25.899 went through eight or nine iterations before it was presented to TSG RAN for information (and in this case simultaneous approval) in May 2004. It contained eight different technologies proposed as candidates for the improvement of the HSPDA physical layer. It was one of ten or so TRs being considered by WG1 at the Priority Date. Many of the proposals being discussed had not progressed, and would not progress, to the work item phase or be incorporated into a TSG-approved TR. Aspects of some proposals were explicitly stated to be "FFS [for further study]". In essence, TR 25.899 v0.2.1 represented no more than a collection of proposals culled from T-docs for evaluation. Thus, even if the skilled person knew of it, it would not have been regarded as a sufficiently reliable foundation for further work.
23. While I accept the submission that Prof Purat must have applied the wrong standard when opining that this document was common general knowledge, given that the

document is no longer relied upon and that there was in the end little disagreement between the experts as to the common general knowledge which is relevant to obviousness over Nortel October, the point has no wider significance.

24. Prof Purat's approach to Qualcomm was to start with TR 25.899, and then work through Qualcomm to see if anything disclosed in it could improve the fractional dedicated channel proposed in the three Nortel contributions included in TR 25.899. Moreover, his opinion was based on reading a single sentence buried in Qualcomm at [0077] as a disclosure of how the F-CPCCH in cdma2000 could be "re-purposed" when that was, to put it at its lowest, not explicitly disclosed. In my view this evidence reeked of hindsight.
25. The fact that an expert witness has fallen into the hindsight trap with respect to one item of prior art does not necessarily mean that his approach to a different item of prior art is infected with hindsight. In this case, however, I consider that Prof Purat's evidence with respect to Qualcomm makes it necessary to approach his evidence with respect to Nortel October with caution given that the cause of the concern is the same i.e. his prior knowledge of the invention.

Technical background

26. The parties agreed a single primer for both Trial A and B, which was primarily directed to EP (UK) 1 440 525. It included material which was not relevant to the Patent, which I have therefore omitted from the following account. I have also supplemented and updated my account from the expert evidence.

Mobile telecommunication standards

27. There are a number of standards for mobile telecommunication systems in operation in different countries. There have been a series of generations of standards, including the second generation (2G), third generation (3G) and fourth generation (4G). Each standard is periodically revised to introduce improvements and new features. New versions are typically called "Releases".
28. Global System for Mobile Communications (GSM) is a 2G system developed by ETSI based on time division multiple access (TDMA) and frequency division multiple access (FDMA) technology. The first version of the GSM standard was released in the late 1980s. By the Priority Date GSM had been commercially launched in many countries around the world, including the UK and throughout Europe. There were 788 million GSM subscribers worldwide in December 2002.
29. UMTS is an example of a 3G system. Work on developing the UMTS standard was begun by ETSI in the mid-1990s and then continued by the 3rd Generation Partnership Project (3GPP).
30. The first full UMTS release, Release 99, was, despite the name, released in March 2000. By the Priority Date Release 5 had been released and work was underway on Release 6, but Release 6 had not been finalised and product development had not started. The first commercial launch of UMTS (Release 99) was in Japan on 1 October 2001. By the Priority Date, UMTS was being rolled out in Europe and Korea. Release 4 of UMTS was commercially launched in the UK in March 2003.

31. IS-95 (later known as cdmaOne) is a 2G system developed primarily by Qualcomm based on code division multiple access (CDMA) technology. The first version of the IS-95 standard was released in the mid-1990s. By the Priority Date IS-95 had been commercially launched in many countries around the world, including in South Korea and the US, but not in the UK or elsewhere in Europe.
32. cdma2000 resulted from work on the evolution of IS-95 towards the third generation and was standardised by the 3rd Generation Partnership Project 2 (3GPP2). The standard had been released prior to the Priority Date and had also been put into use commercially by this time in South Korea and the US. But it had not been put into use elsewhere, including the UK and Europe, by the Priority Date. There were 50 million cdma2000 subscribers worldwide in December 2002.
33. Prior to the Priority Date, 3GPP and 3GPP2 had been working independently on the standardisation of high speed data mobile systems.

Standard setting

34. The purpose of producing standards is to ensure that different items of equipment from different vendors will operate together. For example, a Mobile Station (MS) produced by one manufacturer must be able to work correctly with a Base Station (BS) and other network equipment from other manufacturers. From the consumer's and the network operator's perspectives, therefore, the whole system should work together seamlessly.
35. 3GPP was formed in 1998 to work on developing the UMTS standard. 3GPP is an international standardisation project which includes standard-setting organisations from around the world, for example the American National Standards Institute (ANSI) and the Chinese Wireless Telecommunication Standard (CWTS) as well as ETSI.
36. In the period 2001-2004 3GPP was divided into a number of technical specification groups (TSGs) which were responsible for different aspects of the system:
 - i) Radio Access Network (TSG-RAN);
 - ii) Core Network (TSG-CN);
 - iii) Service and System Aspects (TSG-SA);
 - iv) Terminals (TSG-T).
37. For present purposes, the Radio Access Network technical specification group (TSG RAN) is the most relevant group in 3GPP. TSG RAN in the period 2001-2004 was divided into different working groups, covering various matters related to the operation of base station equipment and mobiles. For example, Working Group 1 (RAN WG1) was responsible for the specification of the physical characteristics of the radio interface. RAN WG2 was responsible for the Radio Interface architecture and protocols (MAC, RLC), the specification of the Radio Resource Control (RRC) protocol, the strategies of Radio Resource Management and the services provided by the physical layer to the upper layers (see further below).
38. Each working group held meetings bringing together delegates from many different stakeholders (predominantly large mobile handset, base station, or semiconductor

manufacturers but also network operators) to propose and discuss contributions to the standard with a view to reaching agreement on what should be incorporated in the version of the standard being worked on.

39. At technical meetings and plenary meetings, the stakeholders would present temporary documents (T-docs) which might then form parts of Technical Reports (TRs) or be drawn together into Technical Specification (TS) documents.

Elements of a mobile telecommunications system

40. Figure 1 below shows the main components of a typical mobile telecommunications network in the 1990s and 2000s at a general level.

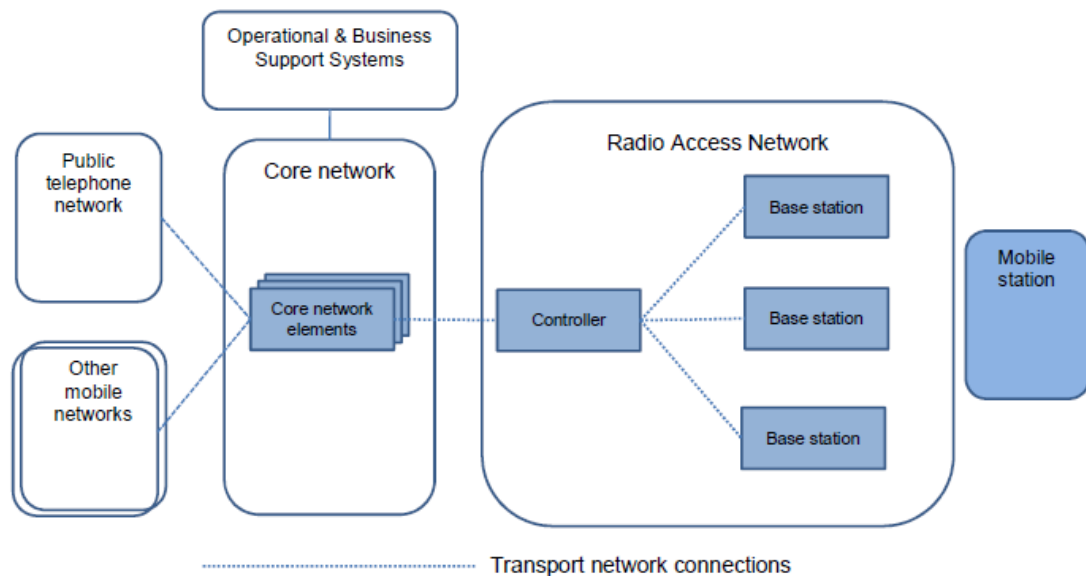

Figure 1 Components of a mobile network

41. Mobility is achieved within the network by facilitating “handover” of an MS between different cells (in this context a cell is a geographic area corresponding to the radio coverage of a BS transceiver) located within the RAN as the MS moves around with its user.
42. The RAN consists of BSs and controllers. A BS is a node of (or point in) the network which provides a number of functions. It sends and receives radio transmissions to and from MSs that are within the cell covered by that BS.
43. MSs are also known as User Equipment (UE) in UMTS. A BS can also be denoted BTS in GSM or Node B in UMTS.
44. The cells of a network are shown schematically below in Figure 2. A BS is found at the centre of each cell. In reality, however, the cells are of a very irregular shape and will have areas of overlap.

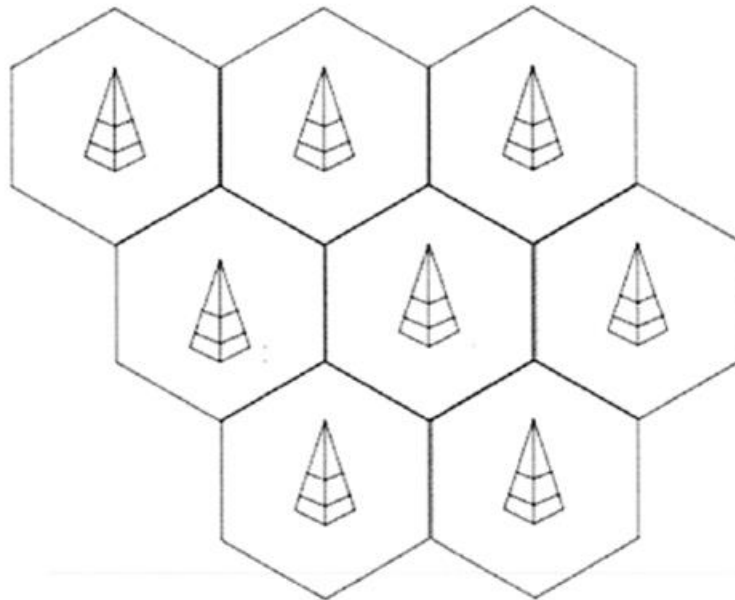

Figure 2 Schematic representation of cells

45. The BSs are connected to a controlling unit (the “Controller” in Figure 1). In GSM this is known as a Base Station Controller (BSC). In UMTS the controller is called a Radio Network Controller (RNC). One of the many functions of the controller is to facilitate handover of a MS between different BSs.
46. As indicated in Figure 1, the Core Network (CN) may interface with other networks such as the public telephone network and other mobile networks.

OSI seven layer model

47. The OSI (Open System Interconnection) model is a common way of describing different conceptual parts of communication networks.
48. The OSI model has seven layers. From top to bottom, these are as follows:
 - i) Layer 7, the Application Layer, which provides services to the user software applications (e.g. email delivery protocols and Hypertext Transfer Protocol (http));
 - ii) Layer 6, the Presentation Layer, performs translation and formatting of information received (which may include the functions of compression/decompression and/or encryption/decryption) to present to the application layer and provides an interface to the Session Layer;
 - iii) Layer 5, the Session Layer, which handles communications at a call level, initiating and terminating the communication between users;
 - iv) Layer 4, the Transport Layer, which provides communication of data between end users. End to end (i.e. terminal to terminal) error control forms part of this layer;

- v) Layer 3, the Network Layer, which provides routing from where the data enters a network to where it leaves it;
 - vi) Layer 2, the Data Link Layer, which provides communication over an individual link within the network. Error control for the link is included in this layer; and
 - vii) Layer 1, the Physical Layer, which is concerned with the transmission of the data over the physical medium itself (i.e. protocols that specify how radio waves sent through the air represent data).
49. The seven layers are shown on both sides of Figure 3 under the images of the MSs and the horizontal arrows reflect the effective links between them (described as logical connections). The curved line shows how the data actually flows down through the layers to provide the required connectivity. It can be seen that the data flows from the Application Layer in one MS down to the Physical Layer where it can be transmitted (over the radio interface) to the Physical Layer of a router element (for example a RNC). The data flows up from the Physical Layer of the RNC to the Network layer where it can be passed to the Network Layer of another RNC and back down to the Physical Layer. Finally, having been transmitted from the Physical Layer of the RNC to the Physical Layer of a second MS, the data flows back up to the Application Layer.

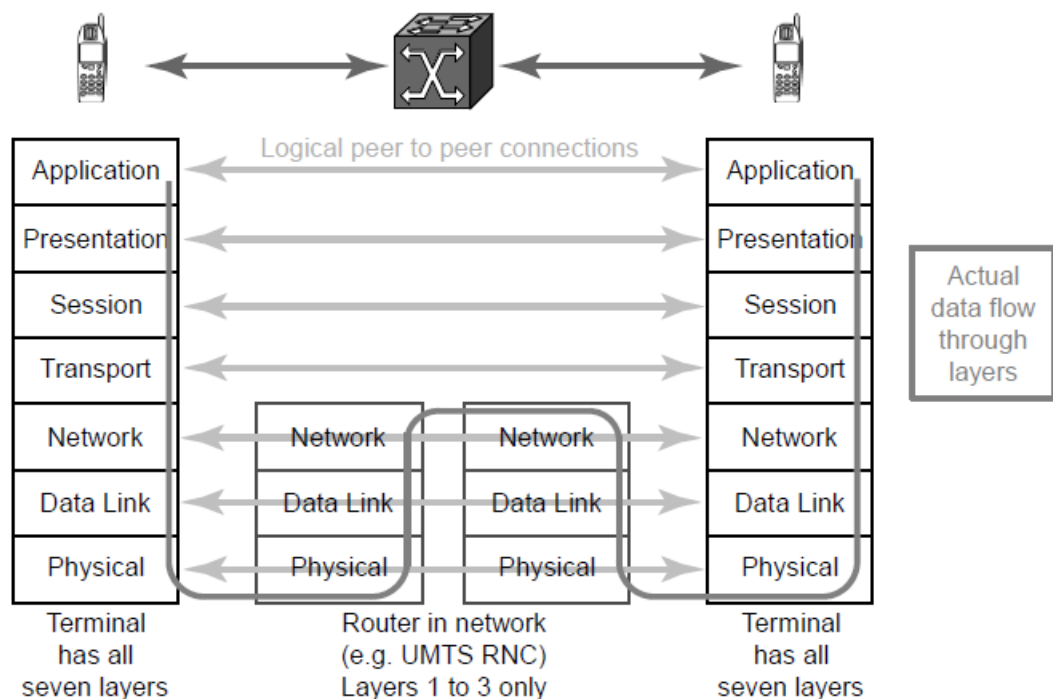

Figure 3 OSI Stack

50. One of the functions in the Data Link Layer is the Medium Access Control (MAC), whose functions include such matters as mapping between logical and transport channels and scheduling.

Channels

51. To facilitate the specification of mobile telecommunications systems, it is common practice to identify a number of types of “channels” with different roles.
52. For present purposes, the “physical channels” used to carry information over the radio interface between the MS and the BS are of particular interest. These channels are associated with the Physical Layer (see Figure 3).
53. Downlink (or forward) physical channels provide communication from the BS to the MS, whereas uplink (or reverse) physical channels provide communication from the MS to the BS.
54. Physical channels may provide a communication path that is dedicated to an individual MS (a dedicated channel), or provide communication between a BS and multiple MSs (a common channel). For example, broadcast physical channels provide communication from a BS to all of the MSs within its coverage area. A shared channel is similar to a common channel, but use of the channel resource is controlled by additional signalling.
55. Physical control channels carry control signals, used for the purposes of maintaining the operation of the system, whereas physical data channels carry user services (such as a voice call or data communication) and may include higher layer control signalling that is not related to the physical layer itself.
56. In some cases, mobile system specifications define other types of channel, which make use of the physical channels. For example, in the UMTS system, the physical layer provides a set of “transport channels” to the MAC layer above it. The MAC layer, in turn, provides a set of “logical channels” to the RLC layer above it. The UMTS logical channels are defined by the type of information they carry.
57. Typically, a mobile system specification defines which physical channels are used to carry each type of higher layer channel. For example, Figure 4 (taken from Holma and Toskala, *WCDMA for UMTS*, 2000) illustrates the mapping of transport channels to physical channels in the UMTS system in 2000.

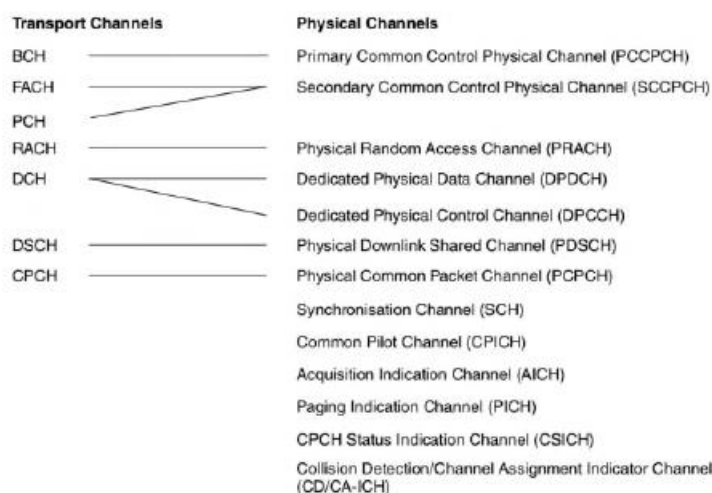

Figure 6.2. Transport channel to physical channel mapping

Figure 4: Transport channel to physical channel mapping

58. Other systems, such as GSM and cdma2000, have their own definitions and mappings of physical and other types of channels, based on similar principles.

Duplexing schemes

59. Duplexing is the process of achieving two-way communications in a system. The two main forms of duplex scheme that are used in cellular communication are Time Division Duplex (TDD) and Frequency Division Duplex (FDD).
60. In TDD bi-directional communication takes place on a single radio frequency channel. The system avoids collisions between uplink and downlink transmissions by transmitting and receiving at different times, i.e. the BS and the MS take it in turns to use the channel.
61. In FDD two (generally symmetrical) segments of spectrum are allocated for the uplink and downlink channels. In this way the BS and MS transmit simultaneously, but at different radio frequencies, thereby eliminating the need for either to transmit and receive at the same frequency at the same time. One consequence of the uplink and downlink transmissions being carried at different frequencies is that the attenuation experienced by each signal could be significantly different as the fast fading (as to which, see below) may differ on the uplink and downlink transmissions. In TDD systems, the fading is likely to be similar on the uplink and the downlink as they generally occur on the same frequency.

Multiple access schemes

62. In any cellular network it is necessary to have a mechanism whereby individual users can be allocated a portion of the radio resources so that they can communicate with the BS using their MS for the duration of a communication. This mechanism is referred to as a “multiple access scheme”. Three of the most common multiple access schemes are TDMA, FDMA and CDMA.
63. CDMA is of most relevance to this case. In CDMA, several users are permitted to send information simultaneously over a single radio frequency channel. The transmissions of the different MSs are separated from each other through the use of codes. CDMA employs spread spectrum technology and a special coding scheme known as Code Division Multiplexing (CDM), where the BS assigns each MS one or more unique codes (known as spreading codes) within one cell. UMTS employs a version of CDMA called Wideband CDMA (WCDMA).
64. CDMA uses spreading codes for channelization. Spreading involves multiplication of low rate data signals representing digital information with channel-specific high rate code signals. The high rate is known as the chip rate. The multiplication spreads the signal power over a large frequency bandwidth. The ratio between the two rates is called the spreading factor.
65. There are a finite number of such codes and each physical layer channel is assigned a single code for transmission. When a code is assigned, it blocks the use of some codes for other channels because codes are selected from a logical structure known as a code tree. Thus codes are an important system resource.

Functions of the radio transmission chain

66. Figure 5 shows the basic components of a radio link, or “transmission chain”, in UMTS.

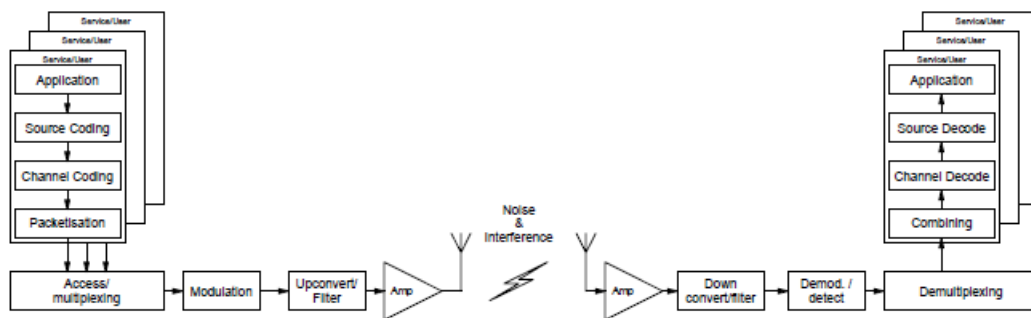

Figure 5 Radio transmission chain

67. Following the arrows in the diagram from the top left: as a first stage, data is taken from the Application Layer (the layer providing a service to the end user of the system) and “source encoded” into an efficient representation for use in the next stages of transmission. For example, source coding may involve an analogue audio speech signal being encoded into a digital signal and compressed.
68. After source coding, the data is channel coded. Channel coding adds symbols to the data to be transmitted in a particular pattern that allows corruption to be detected and corrected. This is particularly important for a radio link since, unlike wired transmission, it is likely that some amount of corruption will occur during wireless transmission.
69. The data is then grouped into packets (“packetized”) and multiplexed to allow more efficient use of resources. Multiplexing includes combining data from different services for an individual user as well as combining data from other users. The data stream is then modulated and converted to radio frequency (RF) for transmission.
70. The final step before transmission is to amplify the signal. The amplification is usually variable so that only so much power is used as is needed to reach the receiver.
71. The receiving system performs the same steps outlined above, but in reverse order. Detection of the received signal is more complicated than modulating the transmitted signal because the receiver has to cope with noise, interference and multipath propagation (discussed below).

Noise and interference

72. Both noise and interference can affect and limit wireless communications. It is therefore important for the levels of noise and interference to be measured in order to determine the optimum power for radio transmissions.
73. The Signal-to-Noise Ratio (SNR) is a measurement which compares the level of a wanted signal to the level of background thermal noise. Thermal noise is approximately white, meaning that its power spectral density is uniform throughout the frequency spectrum. The amplitude of the random white noise is commonly modelled as a

Gaussian probability density function, often described as Additive White Gaussian Noise (AWGN).

74. A related measurement is the Signal-to-Interference Ratio (SIR). Although the terms SNR and SIR are often used interchangeably, noise and interference are not identical phenomena. Interference is any unwanted radio frequency signals that arrive at the receiving antenna from other intended (e.g. BS or MS) or unintended (e.g. electronic equipment, vehicle engines) transmitters.

Signal transmission and detection

75. Information is transmitted on a radio signal by altering its amplitude, frequency or phase, or a combination of these, based on the information to be conveyed, in a process known as modulation. The information is recovered from the radio signal by detecting these changes in the received signal's characteristics in a process known as demodulation.
76. In Quadrature Phase Shift Keying (QPSK) pairs of bits (i.e. 00, 01, 10 or 11) are transmitted by varying the phase of two carrier signals of the same amplitude and frequency: the in-phase (I) carrier signal and the quadrature-phase (Q) signal. The four possible signals in QPSK can be visualised as four symbols in the IQ-plane as shown below:

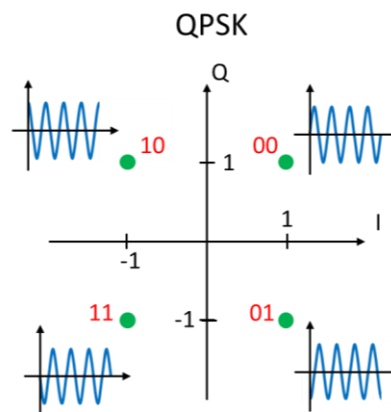

77. Each received symbol has an amplitude (represented by the distance from the origin to the received signal) and a phase (represented by the angle between the axis and the received signal), but information is only encoded in the phase.
78. In order for a receiver to demodulate a received QPSK symbol (i.e. obtain the digital information transmitted) it must know the absolute transmitted carrier phase. This is known as “coherent demodulation”. Without this information the receiver cannot determine which quadrant in the figure above the received symbol lies in and cannot recover the digital information it represents.
79. The transmitter can provide reference signals which carry predetermined information from which the absolute carrier phase can be estimated by the receiver. These are known as “pilot signals” and are discussed further below. Phase estimation can also be achieved without the aid of pilot signals using “decision directed” strategies.

80. Phase estimation is part of channel estimation. Channel estimation involves estimating the power delay profile of the signal due to multipath propagation and estimating the amplitude and phase of the signal, but the expression can also be used to refer to just one of these tasks.

Power control

81. Power control is a fundamental radio resource management feature of mobile telecommunication systems which affects the quality of service experienced by individual users and the overall capacity of the system.
82. As an MS moves around a network, its radio environment changes because of its distance from BSs, obstructions to the radio signals, and reflection, refraction and diffraction caused by surrounding objects leading to multiple propagation paths.
83. Power control is relevant to both the downlink and the uplink of mobile systems, although the specific requirements may depend on the nature of each system.
84. In the context of CDMA systems, the power control mechanism must be able to respond to slow fading and fast fading of the radio signals, as explained below, and also address the so-called “near-far” problem on the uplink/reverse link.
85. *Near-far problem.* The “near-far” problem is illustrated in Figure 15.

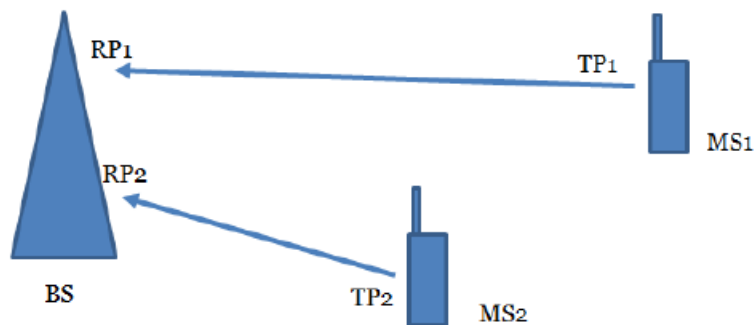

Figure 15 Near-far problem

86. Figure 15 depicts two mobile stations, MS1 and MS2, which are at different distances from the BS. In a CDMA system, the signals of the two mobile stations are sent at the same time and on the same frequency, and are distinguished by means of different codes.
87. Because MS1 is at a larger distance from the base station than MS2, the signal of MS1 is likely to suffer a greater loss of power on its way to the base station than the signal of MS2 (although other aspects of the radio transmission, such as buildings and multipath propagation, will also have a bearing). If MS1 and MS2 transmitted the signals at the same power level, the MS1 signal would be much weaker at the base station than the MS2 signal (Received Power $RP1 < RP2$). There is a risk that the MS2 signal might cause excessive interference, and thus prevent reception of the signal from the more distant MS1 by the BS.

88. Because of this, uplink power control in CDMA systems is designed to ensure the BS receives equivalent power levels from all MSs within its coverage area. Hence, for example, MS1 would generally transmit at a higher power level than MS2 to deliver the same service.
89. *Slow fading.* As an MS moves further from a BS, or behind an obstruction such as a building or a hill, its signal gradually becomes weaker, for example over a period of seconds. As the MS moves closer to the BS, or emerges from the shadow of the obstruction, the signal recovers. This effect is referred to as slow fading.
90. *Multipath (fast) fading.* Like other forms of electromagnetic radiation, the radio frequencies utilised in mobile telecommunications are reflected, refracted and diffracted by interactions with the surrounding environment, such as buildings, street furniture and trees. Radio signals therefore do not follow one straight path between BS and MS, instead many paths can be taken and the signal received at the MS or BS will be a composite of all the various paths taken. This is known as multipath propagation.
91. Depending on the path taken by the radio signal, it will be attenuated (i.e. reduced in strength) and phase shifted (i.e. re-aligned with respect to time) by different amounts. The composite signal received will likewise vary in accordance with the signals received from each individual path. For example, if there is a great deal of subtractive interference or cancellation (due to phase shifting) in the composite signal, it will be received at a reduced power in comparison to a signal that has travelled over a direct path.
92. Additionally, since the MS and the environment around it do not remain static during operation (for example, vehicle movements may affect the path taken by the radio signal), the multipath phenomenon is also dynamic. As a result, the composite signal can rapidly change in power, for example over a period of milliseconds as illustrated in Figure 16 (taken from Holma and Toskala). This effect is known as multipath fading or fast fading. It can be modelled by a statistical model known as Rayleigh fading.

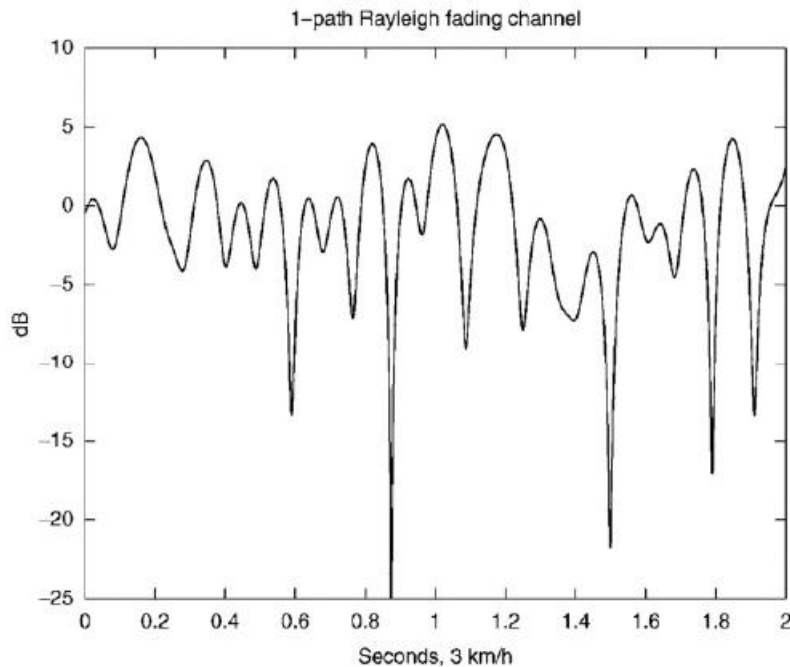

Figure 3.5. Fast Rayleigh fading as caused by multipath propagation

Figure 16 Fast Rayleigh fading caused by multipath propagation

93. Mobile systems based on CDMA have particularly stringent requirements for power control, because users share the same spectrum at the same time and are differentiated only in the code domain. The power transmitted by any device in such a system may create interference for nearby devices operating in the same radio channel.
94. *Power control techniques.* There are two general approaches to the dynamic control of power levels in a mobile system, referred to as “open-loop” and “closed-loop” control. Most mobile systems apply both methods.
95. Open-loop power control requires no feedback from the receiver to the transmitter. The transmitter of a signal (either MS or BS) makes an estimate of the radio propagation conditions, typically based on an estimate of path loss between the MS and BS, and sets its transmission power accordingly (the higher the received signal power, the lower the transmitter power set and vice-versa). This approach relies on the propagation conditions being similar in both directions (uplink and downlink). Given that the geographic distance is the same in each direction, it is a reasonable starting point, although the conditions may be quite different if the uplink and downlink operate on different frequencies. Open-loop power control is often used at the start of a connection, when it is not possible to apply closed-loop techniques.
96. Closed-loop power control uses a feedback loop from the signal receiver to the signal transmitter to control the transmitted power level. For example, on the uplink the BS receiving the MS signal may feedback “power up” or “power down” commands to control the MS transmitter, according to whether the received power level is too low or too high, respectively. Closed-loop power control allows the system to accommodate situations where the signal propagation conditions are different for the uplink and downlink of a system.

97. As part of closed-loop power control it is common to use a combination of “outer-loop” and “inner-loop” control.
98. Outer-loop power control is a mechanism to set a target for inner-loop power control. Typically, the quality of service of a received signal is assessed in some way, for example by determining the error rate of the decoded data. If the error rate of the received data is too high or too low, then the system increases or decreases, respectively, the target power level or SNR for inner-loop power control.
99. Inner-loop power control aims to achieve a defined target level for some parameter of a received signal, such as its SNR. Typically, these are parameters that can be determined quickly, so that power control commands can be returned to the transmitter promptly, to deal with fast fading.

UMTS Release 5

100. At the Priority Date, the most recent finalised version of the Standard was Release 5. Release 5 included the following features.
101. *Downlink channels.* In Release 5, there is only one dedicated transport channel, the Dedicated Channel (DCH), with a corresponding Dedicated Physical Channel (DPCH), in the downlink or uplink. In the downlink, a dedicated physical data channel (DPDCH) and a dedicated physical control channel (DPCCH) are time multiplexed onto the DPCH. The frame structure for the downlink DPCH is shown in Figure 9 of TS 25.211 v5.5.0 which is reproduced below:

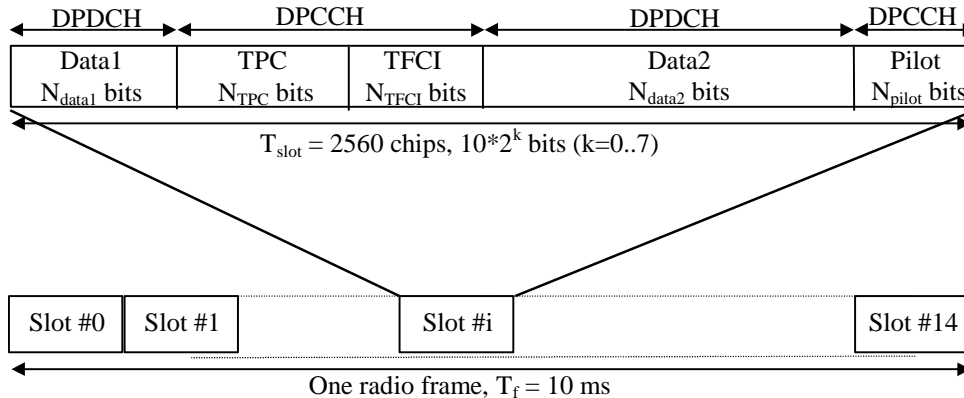

102. A frame of the DPCH is made up of two data fields (the DPDCH) and three control data fields (the DPCCH), namely 2-16 Transmit Power Control (TPC) bits (to control uplink power control), 0-16 Transport Format Combination Indicator (TFCI) bits (to indicate the current data rate and the manner in which different services are multiplexed on the physical resources) and 4-32 dedicated pilot bits (as to which, see below). The figure shows that the frame length on the DPCH is 10 ms and is divided into 15 slots.
103. There are a number of different available slot formats, with varying bits for each type of field. These can be flexibly configured at the cost of additional (higher layer) control signalling. Some slot formats do not include TFCI bits, so the mobile must determine the data rate and multiplexing blindly. Omitting the TFCI bits requires a more complex determination of the downlink physical channel transport format, but allows for more data to be transmitted. TPC and pilot bits are present in all slot formats of the DPCH.

104. In addition to transport channels which are mapped onto physical channels, in UMTS there exist physical channels which are only associated with relevant physical layer procedures i.e. no transport channels are mapped onto them. The Common Pilot Channel (CPICH) is an example of such a physical channel.
105. *HSDPA*. Release 5 included High Speed Downlink Packet Access (HSDPA). This used adaptive modulation and coding, fast scheduling and retransmission combining to provide more efficient and faster transmission of packet data.
106. HSDPA introduced a new shared downlink transport channel, the HS-DSCH, to carry packet data. There were also new physical channels: High Speed Physical Downlink Shared Channels (HS-PDSCHs) and High Speed Shared Control Channels (HS-SCCHs) on the downlink and a High Speed Dedicated Physical Control Channel (HS-DPCCH) on the uplink. The HS-PDSCH carries the actual data while the HS-SCCH contains the scheduling information such as spreading codes and modulation information. The HS-DSCH always uses a spreading factor of 16.
107. The HS-DSCH is not power controlled. An associated downlink dedicated channel allows for the continuation of services which require continuous data transfer, such as voice telephony, as well as the transmission of power control commands and signalling information.
108. *Power control*. In the Release 5 uplink, open-loop power control is used for initial access only. For initial access, the transmission power of the uplink is based on a measurement of the received common pilot. This reference signal is sent at a predetermined power level. After a connection is established, closed-loop power control is used. On the uplink, this is vital to deal with the near-far problem, i.e. signals should be received at the BS at approximately equal power so that quality of service targets are met, but without causing unnecessary interference to other users. Thus MSs that are further away from the BS typically transmit at higher power.
109. In the downlink, there is no near-far problem (because transmissions are one-to-many, using orthogonal codes, rather than many-to-one), but transmissions do cause interference to users in neighbouring cells. Only the dedicated channel is power controlled; common channels are not. Closed-loop power control is used on the dedicated channel.
110. TS 25.214 v5.6.0 sets out the requirements for downlink power control using the DL (downlink) and UL (uplink) DPCCH. Annex B reproduced below is an illustrative figure showing an example of transmitter power control timings.

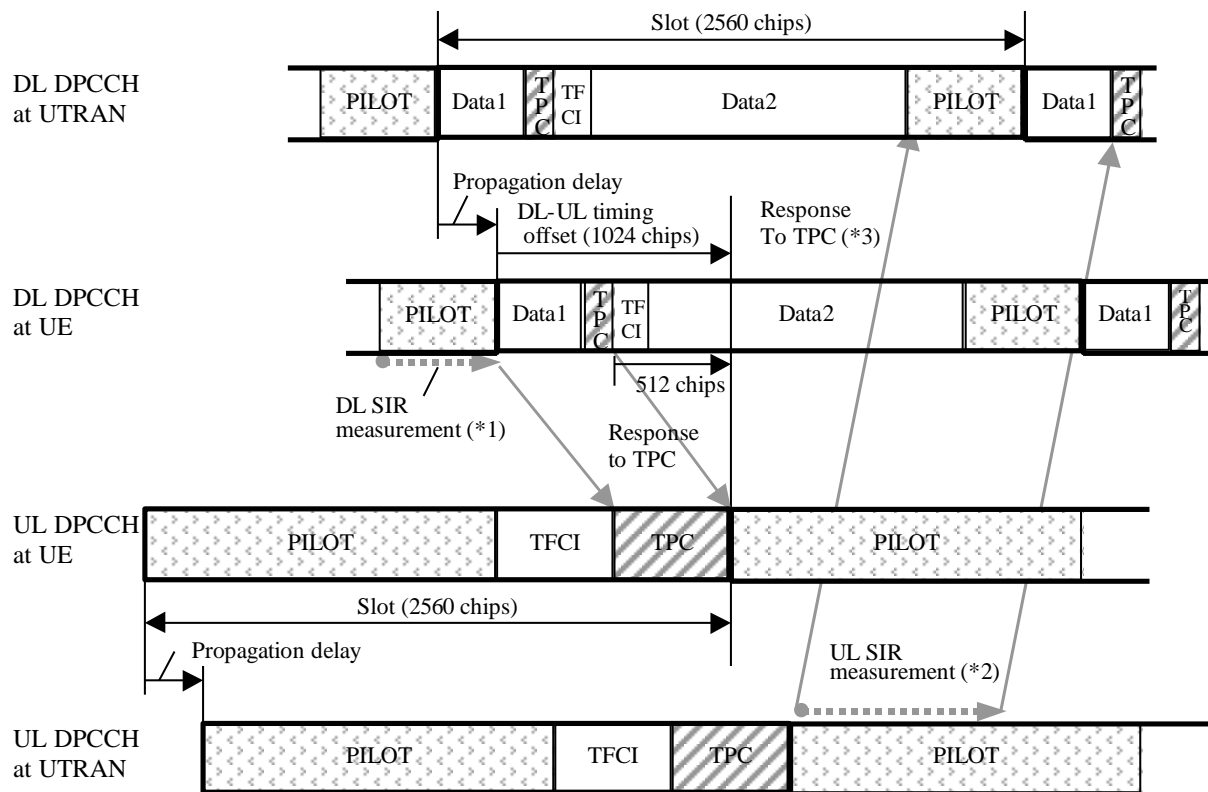

*1,2 The SIR measurement periods illustrated here are examples. Other ways of measurement are allowed to achieve accurate SIR estimation.
 *3 If there is not enough time for UTRAN to respond to the TPC, the action can be delayed until the next slot.

111. The first row shows the BS (UTRAN) transmission of the DL DPCCH. There is a propagation delay to receipt of that channel by the MS (UE) shown in the second row. The MS measures the SIR of the received dedicated pilot bits (discussed further below) and generates a TPC command, instructing the BS to turn the power up or down. At the same time, the MS receives a TPC command, which instructs it to adjust its own transmission power on the uplink.
112. The third row shows the transmission of the UL DPCCH by the MS (offset by the DL-UL timing offset of 1024 chips from the time of receipt of the DL DPCCH, and including the TPC command for the power control of the downlink dedicated channel). The fourth row shows receipt of that channel by the BS, which then acts on the TPC command in the slot immediately following the slot carrying the pilot bits that were measured by the MS. This is known as the “one-slot delay” in the power control loop, i.e. the command to turn up or down the power is received in time to be acted upon by the transmitter in the slot following the pilots that are being measured by the receiver.
113. One-slot delay is not a requirement of the Standard, but failing to adhere to it would affect the overall system efficacy: one-slot delay ensures feedback is received as fast as possible in order to address fast fading. Beyond a certain cell radius, however, one-slot delay cannot be achieved due to propagation delays.
114. SIR estimation has two components: the signal strength and the interference level. In the example implementation shown in Annex B the MS carries out the signal strength

measurement by measuring the amplitude of the dedicated pilot bits at the end of the slot. As footnotes 1 and 2 indicate, other ways of measurement are allowed to achieve accurate SIR estimation.

115. *Pilot signals.* As explained above, pilot signals are predetermined sequences of symbols known to both transmitter and receiver. Pilot signals can be sent on common or dedicated channels. UMTS uses both common and dedicated pilots.
116. *Common pilots.* The Common Pilot Channel is transmitted to all MSs and is not power controlled. The channel identifies a particular BS (through a cell-specific scrambling code). There are two types of Common Pilot Channels: Primary (P-CPICH) and Secondary (S-CPICH). Only one P-CPICH is used in a cell, which is transmitted across the whole cell (save that for transmit diversity, discussed below, a different bit sequence is used on each antenna). There can be more than one S-CPICH, which are used when a narrower sector of the cell is in use.
117. P-CPICH always has a fixed channelization code allocation with spreading factor of 256. S-CPICH can have any channelization code of length 256.
118. The common pilots perform two functions in an ongoing connection: (a) idle mode mobility and handover, and (b) assisting demodulation of downlink physical channels.
119. Adjustment of the transmission power of the P-CPICH encourages cell-edge MSs to move to or from neighbouring cells. The received power of the pilot of neighbouring cells will be measured and reported by MSs.
120. In order to assist with demodulation, the common pilots may be used as a phase reference for downlink channels. Common pilots can also serve as a reference signal for initial chip, symbol and frame synchronisation and as a reference signal for open-loop power control during initial access. These points are discussed further below in the context of common general knowledge.
121. *Dedicated pilots.* All configurations of the DPCCH contain dedicated pilots. As shown in the figure from Annex B reproduced in paragraph 110 above, they are transmitted at the end of each slot. They are transmitted at lower power than the common pilot channel.
122. Dedicated pilots can be used for the following purposes:
 - i) demodulation of the DPCCH/DPDCH (i.e. channel estimation);
 - ii) layer 1 synchronisation;
 - iii) downlink power control;
 - iv) closed-loop transmit diversity with antenna verification; and
 - v) user-specific beamforming.
123. Dedicated pilots are technically necessary for user-specific beamforming and closed-loop transmit diversity using antenna verification. They are not technically necessary

for channel estimation, layer 1 synchronisation or downlink power control. These points are discussed further below in the context of common general knowledge.

The Patent

124. The specification sets out the background to the invention at [0001]-[0006], explaining the role of TPC commands and pilot signals in mobile communication systems. At [0007] the specification states that an object of the invention is “to reduce the requirement for system resources”. After three consistory clauses, the specification states at [0011]:

“The invention is based on the realisation that downlink closed loop power control may be operated by measuring the quality of received downlink non-predetermined data symbols instead of predetermined pilot symbols, and that in some circumstances, separate downlink pilot symbols for each active mobile station are not necessary for channel estimation. In some circumstances, downlink channel estimation is not required at all, and in other circumstances a common downlink pilot signal transmitted at a constant power level may be used instead of separate pilot signals. In some circumstances, the base station transmits a second, non-power controlled downlink signal, or a constant power level downlink signal, the mobile station being adapted to derive a channel estimate from this signal. Consequently, operation is possible using fewer downlink system resources.”

125. The specification explains at [0014]-[0016] that one application for the invention is in UMTS. Reference is made to HSDPA in Release 5, in which data can be sent via the HS-DSCH, but the downlink DCH is still required for transmitting TPC commands for each active MS in order to control the uplink transmit power. As the specification says at [0015]:

“One way of operating the downlink DCH is to configure it as a fractional DCH which comprises only pilot symbols and TPC command, with multiple users multiplexed on to the same channel code in such a way that each user uses the channel code for only a fraction of each timeslot. Signalling is used to assign mobile stations to use a particular channel code and fraction of a timeslot, in order to align the uplink and downlink power control timing. Such a scheme frees up channel codes which can be used to increase system capacity. However the present invention requires even fewer resources.”

126. The specification goes on:

“[0017] The invention is based on the recognition that separate pilot symbols for each active mobile station are not necessary in at least two cases:

- 1) Where the transmitted phase of the DCH is referenced to that of a common pilot signal, for example by using the same

antenna(s) and antenna weights for both DCH and the common pilot signal to which the phase of the DCH is referenced. In this case the characteristics of the radio channel can be estimated from the common pilot signal to which the phase of the DCH is referenced. In this case the characteristics of the radio channel can be estimated from the common pilot signal and this estimate can be used to demodulate the TPC bits. This first case is very likely to apply in HSDPA, as the HS-DSCH will be assigned a common pilot signal as a reference and the same common pilot signal can be used for fractional DCH. Since the total power used by fractional DCH's is not likely to be very large, the benefits of separate antenna beam-forming for fractional DCH will not be large.

2) Where different antenna or antenna weights are used for the common pilot signal and the DCH, but the correlation between them is sufficiently good that the common pilot signal can be used to make a reasonable channel estimate for the DCH, such that the data on the SCH can be received reliably.

[0018] So, in accordance with the invention the downlink fractional DCH can consist only of non-predetermined information bits multiplexed between users. A special case of interest is where these information bits carry TPC commands. The amplitude of individual TPC bits may be adjusted by the base station according to power control commands received from the relevant mobile station. The mobile station determines the radio channel phase characteristics from the appropriate common pilot signal, demodulates the TPC commands, and increase or decreases the mobile station uplink DPCCH power as required. In addition, the mobile station uses the amplitude of the received TPC bits to determine any TPC commands sent in the uplink.”

127. In a nutshell, the invention is to dispense with the dedicated pilot bits in the fractional DCH and to use the common pilot signal or the TPC bits instead. This frees up system resources.
128. The specification goes on briefly to explain the invention by reference to two schematic diagrams. It teaches that, using the invention, one slot of the fractional DCH can support 2, 5 or 10 users with 5, 2 or 1 symbol per TPC command. If STTD is used, there are 20 symbols per slot, so 10 users can be supported while maintaining the 2 symbols per TPC required for STTD encoding. As the Defendants emphasise, the specification contains no details of how to implement the invention. In particular, it does not describe how the measurements of signal strength are to be derived from the power control commands, how synchronisation is to be maintained or how any particular power control loop timing can be achieved. The specification assumes that the skilled person would know how to do these things from his common general knowledge. It is common ground that he would.

The claims

129. As proposed to be amended, broken down into integers and omitting reference numerals, claim 1 is as follows:

- “[1] A mobile station for use in a UMTS communication system in FDD mode operating HSDPA having a base station, the mobile station comprising:
- [2] receiver means for receiving from the base station a first downlink signal on a downlink dedicated channel configured as a fractional dedicated channel which comprises only second power control commands, with multiple users multiplexed on to the same channel code;
- [3] measurement means for measuring a parameter of the received first downlink signal;
- [4] power control means for generating first power control commands in response to the measured parameter; and
- [5] transmitter means for transmitting the first power control commands to the base station;
- [6] wherein the first power control commands are used by the base station to adjust the power of the part of the fractional dedicated channel corresponding to the mobile station;
- [7] wherein the measurement means is adapted to measure the parameter of the first downlink signal while the first downlink signal is modulated with non-predetermined data values
- [8] and is subjected to transmit power control in accordance with the first power control commands.”

130. Claim 2 is as follows:

- “[1] A mobile station as claimed in claim 1
- [2] wherein the receiver means is adapted to receive from the base station a second, non-power controlled downlink signal
- [3] and to derive a channel estimate from the second downlink signal,
- [4] and to employ the channel estimate to decode the first downlink signal.”

131. Claim 3 is as follows:

- “[1] A mobile station as claimed in claim 1 or 2

- [2] wherein the power control means is adapted to decode the non-predetermined data values of the received first downlink signal comprising second power control commands
- [3] to adjust the transmit power of the transmitter means in accordance with the decoded second power control commands.”

132. The Defendants contend that the amendments to claim 1 are impermissible on the ground that they add matter. In short, the Defendants say that the amendments to claim 1 constitute an intermediate generalisation. The Defendants accept, however, that the amendments to claim 3 are not objectionable on this ground. It is common ground that, as between Philips and the Defendants, it is not necessary for the Court to decide whether the amendments to claim 1 are allowable because (i) the Defendants do not dispute that, if claim 3 as proposed to be amended is valid, then it is infringed and (ii) Philips does not contend that, if claim 1 as proposed to be amended is obvious over Nortel October, claim 3 is independently valid. In those circumstances, and given that, in the absence of fuller argument, I am not convinced that the amendments are impermissible, I will allow the amendments if amended claim 1 is not obvious over Nortel October.

Construction

133. There is no dispute as to the construction of the claims. As the Defendants emphasise, however, it is necessary to be clear as to what the claim does not require. It does not include any performance requirements. Nor does it require that the modified fractional dedicated channel be compatible with any particular existing UMTS feature, such as user-specific beamforming or closed-loop transmit diversity with antenna verification.

The skilled person

134. There is a small dispute between the parties as to the identity of the person skilled in the art to which the Patent is addressed. It is common ground that the skilled person would have a degree in electronic engineering (or a similar subject) and would have worked in the mobile communications industry for three to five years. It is also common ground that the Patent is particularly addressed to someone who is working on UMTS, especially HSDPA.
135. The dispute has two aspects. The first, which I do not consider matters, is whether or not the skilled person could be someone developing products compatible with the Standard. The second, which I consider more significant, is whether the skilled person would be working on implementing Release 5 or on developing the Standard towards Release 6.
136. So far as the first point is concerned, the experts were agreed that, in addition to (i) standards delegates who regularly attended meetings, there were also (ii) people who either occasionally attended meetings when a specific topic of interest was to be discussed, (iii) people who worked behind the scenes providing support to standards delegates and (iv) people who were developing products compatible with the Standard. The experts also agreed that standards delegates could have a range of experience and abilities, although they tended to be more experienced and some were inventive. They

also agreed that people in category (iii) would be kept up to date with discussions in WG1 by those who attended the meetings.

137. It is common ground that the Patent would be of interest to people in categories (i) to (iii). Mr Kahtava considered that the Patent would also be of interest to those in category (iv). Prof Purat distinguished in cross-examination between those who were system engineers considering the future development of products and improvements and those who were purely making commercial products implementing a completed standard. He thought that the Patent was addressed to the former, but not the latter. I am inclined to agree with this, but I do not think it matters. More importantly, it was Prof Purat's evidence that the skilled person would have some familiarity with how to implement the physical layer in practical systems, and to the extent that he was not familiar with the detail of implementation issues he could consult colleagues specialising in implementation.
138. Turning to the second point, Mr Kahtava expressed the opinion in his first report that the skilled person would be an individual involved in the design and implementation of the physical layer aspects of devices and methods for use in UMTS, and specifically would be interested in the implementation of the physical layer aspects of HSDPA in Release 5. As Mr Kahtava accepted, however, the problem which the Patent seeks to address is to improve the UMTS radio interface from Release 5 in order to reduce code usage. The first and crucial step in this is to specify the new channel required by both Nortel October and the Patent, which involves amending the Standard. Moreover, as Mr Kahtava also accepted, an MS implemented in accordance with Release 5 would not support the new channel. Accordingly, I accept the Defendants' submission that the skilled person would be someone working on improvements to the physical layer aspects of Release 5. Such a person would be focused on developing the Standard, rather implementing Release 5. That does not mean that he would be oblivious to implementation issues, however.

Common general knowledge

139. There is little, if any, dispute that everything I have set out in the technical background section was part of the skilled person's common general knowledge. As noted above, there was in the end little disagreement between the experts as to the common general knowledge that is relevant to obviousness over Nortel October. Such disagreement as there was centred on the perceptions of the skilled person as to the uses of dedicated pilot signals in Release 5 of UMTS. This is largely a question of emphasis, although in certain respects it goes beyond that.

cdma2000

140. It is common ground that the operation of cdma2000 would be common general knowledge to the level of detail described in chapter 14 of the second edition of Holma and Toskala, *WCDMA for UMTS* (2002). This describes cdma2000 closed-loop power control at pages 379-380 and 383 in the following terms:

“While the uplink direction has power control information multiplexed with the pilot channel, the downlink direction has only common pilot [sic] and the power control information is multiplexed with the data stream by puncturing with the rate of

800 Hz. The power control symbols are transmitted at a constant power level, as indicated in Figure 14.6, and serve as the only power reference for power control operation. The data symbols have a varying power level, since the rate matching is done with repetition or puncturing and the channel symbol rate is kept constant. The common pilot channel used as a phase reference is similar to UTRA [i.e. UMTS] CPICH. ... There are some fundamental differences from UTA FDD, in addition to the multi-carrier structure. The Fundamental Channel does not carry pilot symbols or rate information data.”

“The basic power control procedure is rather similar in the MC mode [i.e. cdma2000] and UTRA FDD. Fast closed-loop power control is available in both uplink and downlink. Many of the details are different, however. ... For the algorithm in the terminal, one difference is caused by the pilot solution. In the MC mode the pilot symbols do not exist on the dedicated channel, thus the only symbols that can be used to aid the SIR estimation are the power control symbols as they preserve the power levels unchanged with respect to change in the data rate.“

141. Consistently with this, Mr Kahtava accepted that it was common general knowledge that:
- i) the basic power control procedure in cdma2000 is similar to that in UMTS;
 - ii) cdma2000 does not perform power control measurements on pilot bits, it performs them on TPC bits; and
 - iii) where reference is made to the TPC bits being transmitted at a constant power level, this means that they do not vary with the data rate on the channel, not that they do not vary in accordance with power control commands.

Uses of downlink dedicated pilot signals

142. *Power control.* It was common ground between the experts that the skilled person would consider that SIR measurement by the MS on the dedicated pilot bits for the purpose of power control was a sensible choice to achieve one-slot delay, and hence that the dedicated pilot bits were practically useful for power control. Mr Kahtava’s evidence was that the skilled person knew that in practice SIR measurement was done on the dedicated pilot bits. Prof Purat accepted that the skilled person would know that the dedicated pilot bits were in fact used for this purpose, although he would not know if all implementations did so at the Priority Date.
143. It was also common ground between the experts that the skilled person would know that SIR measurements could be carried out on any type of bits, whether pilots or otherwise. Mr Kahtava’s evidence was that the skilled person would regard the dedicated pilot bits as optimal for this purpose due to their position at the end of the downlink slot, and I understood Prof Purat to accept this. But the skilled person would know that using TPC bits would be satisfactory.

144. *Channel estimation and phase reference.* There is some dispute between the parties as to the extent to which the skilled person would understand that dedicated pilots as opposed to common pilots were used for channel estimation, and specifically phase reference, in UMTS Release 5. Each side relied upon different passages from the evidence of the experts to support their respective cases on this issue. Having considered all the evidence references, my findings are as follows.
145. The skilled person would be aware that, depending on the factors considered below, (i) the dedicated pilots, (ii) the common pilots or (iii) both the dedicated and the common pilots could be used for channel estimation.
146. TS 25.211 version 5.5.0 states that “by default” the P-CPICH is a phase reference for downlink DPCH and any associated PDSCH, HS-PDSCH and HS-SCCH. S-CPICHs may be used where fixed-grid beamforming is employed. The common pilot channels cannot be used where there is user-specific beamforming or closed-loop transmit diversity with antenna verification, however.
147. The common pilots are better suited to being a phase reference than the dedicated pilots as they are transmitted at higher power and continuously. Thus using the dedicated pilots would give a worse channel estimate than using the common pilots.
148. The skilled person’s preference would be to use both the common and dedicated pilots for phase estimation because that would make use of all the available energy, but there could be implementation reasons for not doing so. If both were used, the bulk of the energy would come from the common pilots. Save in the circumstances identified in paragraph 146 above, the dedicated pilots are not technically required for this purpose.
149. *Layer 1 synchronisation.* The word “synchronisation” can refer to various features of UMTS:
- i) First, a receiver must locally regenerate the chip code signal and synchronise this signal in time to the received code signal, because any shift between the received and locally generated chip code signal would produce a high rate signal after multiplication and, therefore, cause the despreader to suppress the desired data signal. This is called chip synchronisation.
 - ii) Secondly, the receiver must know the timing of the data symbols which are multiplied with the chip codes. This is called symbol synchronisation.
 - iii) Thirdly, the symbols which are communicated between transmitter and receiver need to be structured in some way so that the receiver can understand their meaning. This is typically accomplished by temporally framing the bits. Finding the correct timing of frames is called frame synchronisation.
150. It was common ground between the experts that, in UMTS, the common pilot signal is used for chip synchronisation, symbol synchronisation and frame synchronisation during initial access. Mr Kahtava’s evidence was that the skilled person would appreciate that, once the dedicated channel was established, the dedicated pilots could conveniently be used for synchronisation. Prof Purat agreed that UMTS Release 5 provided the option of verifying the frame synchronisation of the DPCH using the dedicated pilots. He also accepted that the skilled person would understand that using

the dedicated pilots was a practical way of maintaining frame synchronisation and that they were in fact used for that purpose.

151. A separate point is that the MS is required to offset the uplink dedicated channel by 1024 chips from receipt of the downlink dedicated channel. Mr Kahtava regarded this as another form of synchronisation, while Prof Purat disagreed with that use of the term even though he himself used the verb “synchronise” in this context. This does not matter, however. Mr Kahtava’s evidence was that a practical way of doing this was for the MS to count 1024 chips from the end of the dedicated pilot field, but he accepted that using the dedicated pilot was not technically necessary and that there were other ways of doing it. Prof Purat accepted that counting 1024 chips from the end of the dedicated pilot field was a possible implementation, but he thought that it was more common to use the common pilot. I conclude that the skilled person would be aware that it could be done either way.
152. *Closed-loop transmit diversity*. It is possible to take advantage of naturally occurring multipath diversity to improve the quality of received signals. Where multipath diversity does not occur naturally, it is possible to generate multipath propagation by adding a second antenna at the BS which, in suitable environments, can reduce transmit power requirements and therefore reduce overall interference in the system. In the uplink, the same signal will then be received twice on different paths, which allows the power of the two received signals to be combined. The two different channels can be estimated without any problem because the receiver chains from the two antennas are physically distinct. In the downlink, the situation is more challenging: without taking any measures to provide diversity, there is only one received signal at the MS antenna. Therefore 3G systems employ “transmit diversity” techniques that allow for diversity combining in the downlink.
153. Methods of transmit diversity techniques can be broadly categorised into open-loop and closed-loop techniques:
 - i) Orthogonal transmit diversity (OTD). This is an open-loop method, where the symbols are split into two streams with even and odd numbered symbols which are then transmitted from the two antennas using two different spreading codes. The receiver will process the two spread signals as two independent data signals using two conventional receivers with different spreading codes for each stream. The two receivers require two channel estimates, one for each antenna. Finally, the two data streams are merged into one. Support for OTD is a feature of cdma2000.
 - ii) Space time transmit diversity (STTD). This is an open-loop method, where both the even and odd numbered symbols are transmitted from the two antennas at different times, but with the same spreading code which adds an additional time diversity gain compared to OTD. The received signal is then processed in a single receiver using only one spreading code but with additional processing to combine two versions of the received signal, where the two versions are generated by making use of two channel estimates, one for each antenna. Support for STTD is required by UMTS Release 5.
 - iii) Closed-loop transmit diversity. Closed-loop transmit diversity techniques apply variable antenna weights (modifications to the amplitude and/or phase of the

signal) controlled by feedback information sent from the MS to the BS, so that the transmitted signals interfere constructively at the receiver's antenna. This provides a coherent combining gain at the receiver, allowing a further reduction in transmission power for low mobile speeds. For high mobile speeds, the performance of closed-loop transmit diversity degrades and may be even worse than without transmit diversity. Support for closed-loop transmit diversity is required by UMTS Release 5.

154. In open-loop transmit diversity, the primary common pilot is used as a phase reference (unless user-specific beamforming is being applied).
155. The effectiveness of closed-loop transmit diversity can be improved by using both common and dedicated pilots in a technique known as antenna verification to estimate the antenna weight adjustments made by the BS. Although closed-loop transmit diversity could be done without antenna verification, the skilled person would not consider this to be a practical approach. It is common ground that closed-loop transmit diversity with antenna verification requires dedicated pilot bits.
156. Prof Purat's evidence, which I found persuasive, was that closed-loop transmit diversity was more beneficial for high power channels than low power channels because high power channels cause greater interference.
157. *Beamforming*. Beamforming is another technique which make use of multiple antennae in the BS. In contrast to transmit diversity, which is based on two independent channels, beamforming exploits coherence between the signals to produce regions of constructive and destructive interference in the cell. Different weight factors are applied to the antennae to produce narrow "beams".
158. There are two types of beamforming:
 - i) Fixed-grid beamforming. As the name indicates, this involves a fixed grid of beams. This is done using a predefined set of weight factors. Beam-specific reference signals are required, but these can be sent on common channels.
 - ii) User-specific beamforming (also known as space division multiple access or SDMA). As the name indicates, this involves beams which serve individual users.
159. It is common ground that dedicated pilots are required for user-specific beamforming. This is because the common pilots cannot provide a phase reference for a user-specific beam.
160. Beamforming reduces interference for other cell users and adjacent cells. Again, Prof Purat's evidence, which I found persuasive, was that beamforming was more beneficial for high power channels than low power channels.
161. There was some debate between the experts as to the pros and cons of the two types of beamforming. It was put to both witnesses that their opinions on this question had been influenced by their own personal experiences. As counsel for the Defendants pointed out, there are two contemporaneous publications in which the authors express a preference for fixed-grid beamforming, whereas there are none in which a preference

for user-specific beamforming is expressed. In any event, Mr Kahtava accepted that, at the Priority Date, it was not clear that user-specific beamforming had advantages over fixed-grid beamforming. There also seems to have been some doubt as to whether the high-speed channels could be subject to beamforming at all.

162. Support for user-specific beamforming is optional in UMTS Release 5, and thus the network cannot assume that all MSs implement it.

Backwards compatibility

163. Backward compatibility is a property of a system, product, or technology that allows for interoperability with an older legacy system, or with input designed for such a system, especially in telecommunications and computing. In particular, in the present context, it means that MSs which work with older versions of the Standard (whether Release 99, Release 4 or Release 5) should continue to work when a new version is introduced. But that does not necessarily mean that the introduction of new functionality may not come at the expense of reduced performance of legacy devices in some respects. I did not understand there to be any disagreement between the experts that the skilled person would aim to maximise backwards compatibility, but that this was not an absolute requirement.

Implementation issues

164. Counsel for the Defendants suggested to Mr Kahtava that the issues arising out of implementation of the Standard by MS manufacturers were issues of cost. Mr Kahtava's evidence was that the skilled person would regard implementation as involving issues of cost, complexity and performance. I accept this in general terms, but it does not necessarily follow that any particular implementation step would involve complexity and performance issues as well as cost issues.

Nortel May and Nortel October

165. Although the Defendants primarily rely upon Nortel October, since it is common ground that that it would be read with Nortel May and since Nortel May came first, it is convenient to begin with Nortel May.
166. *Nortel May*. Nortel May is entitled "Fractional[sic] dedicated physical channel". The introduction explains that the proposal overcomes an anticipated code limitation problem in HSDPA, namely that there are finite codes available and each mobile requires its own dedicated physical channel for HSDPA operation (which uses a code). It is noted, however, that "data-only users do not need the DL dedicated codes except for layer 1 control information as higher layer signalling may be carried through HSDPA channels". The introduction concludes:

"The principles presented here allow to reduce the number of codes needed to operate HSDPA in a cell. It was designed to ensure a maximum backwards compatibility with existing UMTS features thus minimising the impact on both the UE and the node B."

167. Section 2, “Code tree utilisation with existing HSDPA design”, explains that, even if the user wants a data-only service, there is still a need from the system perspective to set up a dedicated physical channel in the downlink. This dedicated channel will mainly be used to carry RRC signalling. If the RRC signalling is carried on the HS-DSCH channel, then only TPC and pilot bits will be transmitted on the dedicated channel, which “does seem like a waste of resource”.
168. Nortel May explains that, if the timing is well chosen, the channels could be mapped on the same code without any loss of information, reducing the code tree utilisation. This principle is described as “re-using dedicated code channels among data-only HSDPA users”.
169. Nortel May elaborates on the proposal in section 3, “Fractional dedicated channel”. This is divided into five parts. Section 3.1, “Principles”, begins by explaining that, when designing this channel, Nortel took a number of constraints into account “to ensure maximum backwards compatibility with existing features for the UE and node B”. These were as follows:
- “● Keep the UL [uplink] timing unchanged
 - Maintain the closed loop power control periods
 - Layer 1 synchronisation not impacted
 - Dedicated channel establishment can be made directly with fractional dedicated channel in the downlink and dedicated channel in the uplink
 - Compatibility with soft handover, compressed mode, open-loop Tx [transmit] diversity
 - Keep downlink power control active to avoid transmitting at the maximum power.”
170. The evidence of the experts was that the reference to keeping the UL timing unchanged would be understood by the skilled person as a reference to the 1024 chip offset between the downlink and uplink dedicated channels. The reference to maintaining the closed-loop power control periods would be understood as a reference to maintaining the periodicity of transmitting one TPC command per slot, consistently with the statement quoted in paragraph 172 below. The reference to layer 1 synchronisation not being impacted would be understood as a reference to keeping the downlink pilot which can be used to verify frame synchronisation.
171. Nortel May states that the fractional dedicated channel can be seen as “a shared power control channel i.e. one code is shared between different users to carry power control and pilot bits”. This is illustrated by a figure showing three UEs sharing the fractional dedicated channel using time multiplexing:

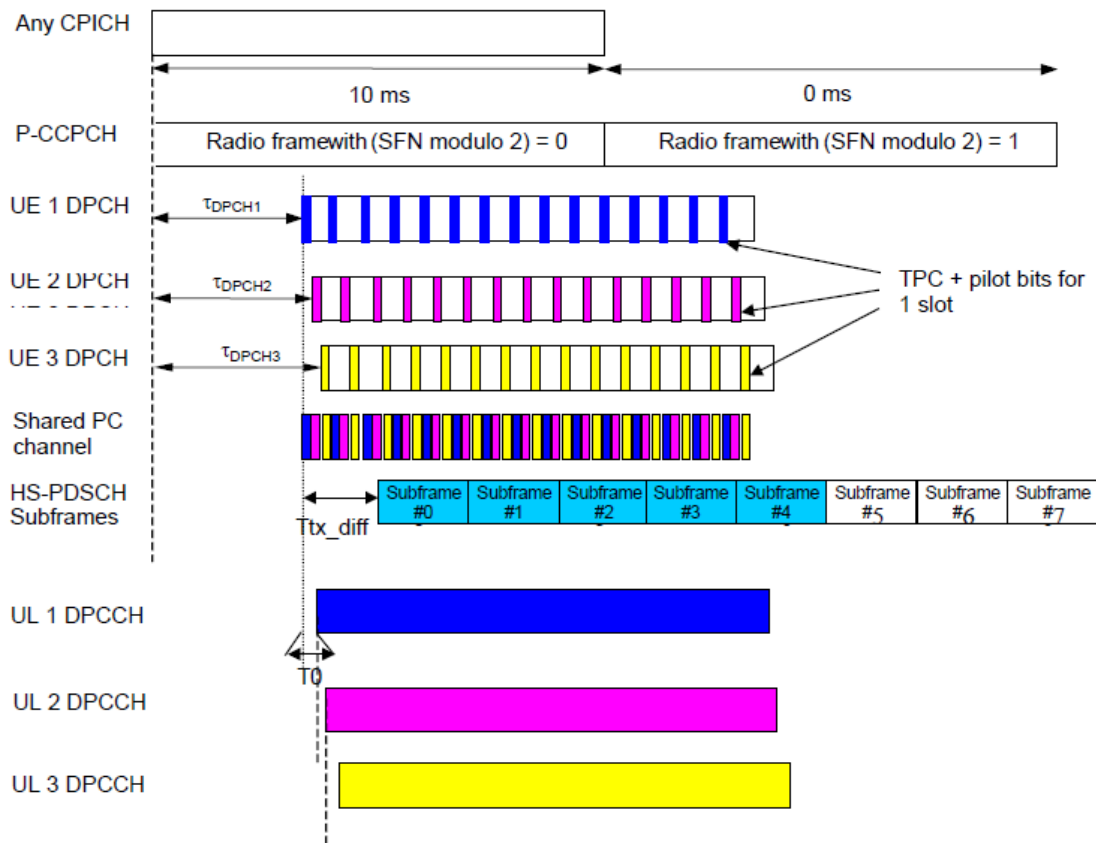

172. Nortel May explains:

“When the DL [downlink] timings of these channels are properly chosen, it appears that the code dimension is not necessary to distinguish between the UEs.

Therefore as illustrated by the Shared PC channel a single code is sufficient to carry TPC and pilot bits associated to these HSDPA Ues and still maintain the periodicity of one slot for the transmission of these information in the downlink.”

173. In section 3.2, “From the UE perspective”, Nortel May explains that, seen from the perspective of one UE, the fractional dedicated physical channel is “very close to an existing DPCH channel except that these different bit types [i.e. TPCs and pilots] are grouped as opposed to the current DPCH format”. This is illustrated by the following diagram:

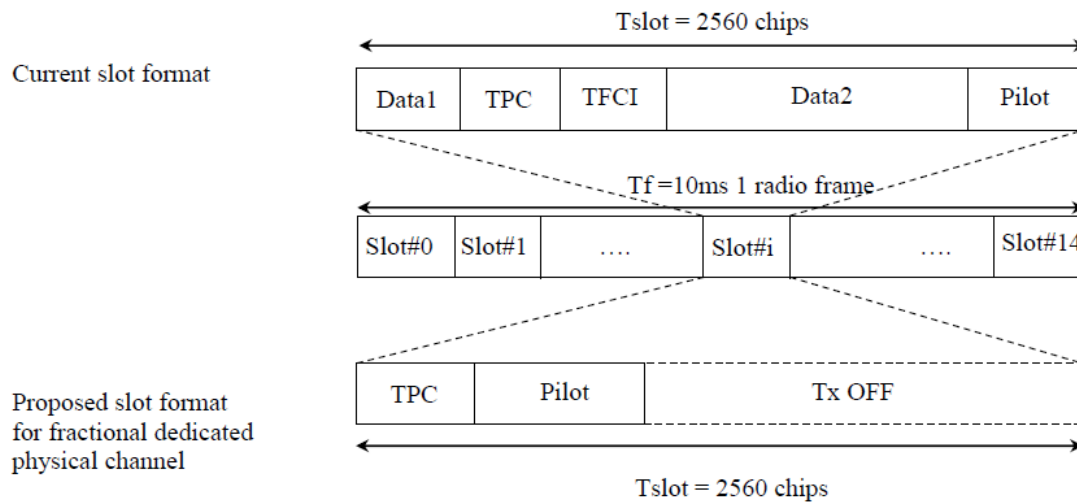

174. Nortel May goes on:

“However except for this difference, seen from a given UE, the fractional dedicated channel can be described by code and timing characteristics exactly as the existing DPCH channel.

Thus

- the power control loop can be maintained with a 1 slot delay
- layer 1 synchronisation can be acquired and maintained using the dedicated pilots (same pattern can be re-used from R[elease]99)
- connection can be established directly in the above described mode without any need for reconfiguration between classical dedicated and fractional
- open loop Tx diversity can be applied provided that the number of symbols for a given UE is a multiple of 4
- timing of associated UL dedicated channel can be kept unchanged i.e. DL and UL radio frame boundaries can keep the same offset whether in soft handover or not.

The proposed channel reuses the existing physical layer procedures thus minimising the impacts on the UE.”

175. In section 3.3, “From the node B perspective”, Nortel May explains that there are two ways of implementing the shared power control channel from the perspective of the base station.

176. In section 3.4, “How many fractional dedicated channels can use a single code?”, Nortel May says that the answer obviously depends on the spreading factor. It goes on:

“When considering the number of TPC and pilot bits dedicated to a given user, maximum backwards compatibility should be targeted i.e. when possible numbers derived from existing slot formats should be considered so that layer 1 synchronisation procedures and features as e.g. beamforming are not affected.

Considering the slot formats defined in TS 25.211, we believe that the number of pilot bits should not be changed to keep the same pilot bit patterns as in existing UMTS releases. In addition, since the objective is to allow the use of STTD [i.e. open-loop transmit diversity] on the fractional dedicated channel, the number of TPC and Pilot symbols for a given UE should be a multiple of 4.”

177. Nortel May then sets out a table with seven options (where “Nb” stands for number):

SF	Nb symb/slot (tot)	Nb TPC symb	Nb Pilot symb	Nb Ues per code
128	20	2	2	5
64	40	2	4	5
64	40	2	2	10
32	80	4	4	10
32	80	2	2	20
16	160	4	8	13
16	160	2	2	40

The evidence of the experts was that (somewhat surprisingly) Nortel did not accurately reproduce the numbers of TPC and pilot bits from existing slot formats in this table; but this error was largely corrected in Nortel October.

178. Underneath the table, Nortel May states:

“Only spreading factor[s] down to 16 are presented, we believe that this shared power control channel (seen as single channel) should have a rather high spreading factor to ensure that it does not consume to[o] much power in the downlink.”

The skilled person would understand from this that the fractional dedicated physical channel was to be a low power channel.

179. In section 3.5, “Analysis of backwards compatibility”, interactions with existing features of UMTS are considered, namely downlink power control, open-loop transmit diversity, soft handover and compressed mode.

180. Nortel May concludes by stating that the proposal allows a wider use of HSDPA by reducing the code limitation problem especially in data-only environments, making it a good candidate technology for the HSDPA enhancement discussions. A text proposal is annexed for inclusion in section 5 of TR 25.899.

181. *Nortel October*. After a cross-reference to Nortel May, Nortel October sets out an expanded text proposal for inclusion in section 6 of TR 25.899. The first section of the text proposal, “6.x.1.1 Rationale and high level description”, states that the purpose of the Fractional Dedicated Physical Channel (F-DPCH) is to share given codes among

HSDPA data-only users to allow a more efficient management of the code resource. It goes on:

“The following requirements apply:

- UL timing is kept unchanged
- UL inner loop power control periods are maintained
- layer 1 synchronisation should – if possible – not be affected
- UL dedicated channel can be established in association to F-DPCH in the DL to avoid reconfiguration when switching to F-DPCH
- Downlink power control can be applied on F-DPCH to avoid transmitting at the maximum power

In order to fulfil these requirements and maximise the number of UE which can be multiplexed on one code, it is assumed that:

- *DCCH signalling* is carried on HS-DSCH
- *UE specific TPC bits* are present to maintain UL power control loop for each UE
- *Pilot bits* are present to allow the F-DPCH to be power controlled and allow DL synchronisation to be maintained by each UE.”

182. Section 6.x.1.2, “F-DPCH slot structure” simply says “[tbc]”. The skilled person would understand “slot structure” to refer to the locations of the different fields in the slot (for example, as shown in paragraph 101 above).

183. Section 6.x.1.3, “Relationships with existing UTRAN [UMTS] features”, states:

“The interactions with the following features are FFS:

- Tx diversity: which type of tx diversity scheme may be applied to F-DPCH?
- Soft handover: does F-DPCH support soft handover?
- Compressed mode: does it apply to F-DPCH?
- Power control
- Beamforming”

184. Section 6.x.2.1, “Gain in code tree consumption”, states that the number of UE which can be multiplexed on a single code obviously depends on the chosen spreading factor and also depends on “the desired number of TPC and pilots [sic] bits”. Nortel October

sets out a table with four options based on the existing numbers of pilot bits in TS 25.211:

Structure	SF	Nb symb/slot (tot)	Nb TPC symb	Nb Pilot symb	Nb Ues per code
1	128	20	1	2	6
2	128	20	1	4	4
3	64	40	1	4	8
4	32	80	2	4	13

The skilled person would notice that, compared with Nortel May, spreading factors of less than 32 are no longer considered, which the skilled person would understand was to avoid high power consumption. The skilled person would also notice that the minimum number of TPC symbols has been reduced to one, whereas the minimum number of pilot symbols has not been reduced below two.

185. Nortel October then sets out the corresponding gains expressed as factors:

Structure	Gain
1	3
2	2
3	2
4	1.625

Thus structure 1 permits 6 UEs per code, a three-fold gain,

Obviousness over Nortel October

186. *Difference between Nortel October and claim 1.* It is common ground that the only real difference between Nortel October and claim 1 as proposed to be amended is that Nortel October does not disclose omitting pilot bits from the fractional dedicated channel.

187. It is convenient to mention at this juncture that another criticism which counsel for Philips made of Prof Purat's evidence was that Prof Purat had, counsel submitted, given evidence that TR 25.899 v0.2.1 (the content of which is materially the same for this purpose as that of Nortel October) disclosed a fractional dedicated channel with no dedicated pilot bits. Counsel for Philips submitted that this was contrary to the plain teaching of the document and demonstrated that Prof Purat was reading it with hindsight. Counsel for the Defendants disputed this. He submitted that the witness had not noticed the use of the word "disclose" by the cross-examiner and had not intended to suggest that TR 25.899 disclosed using no dedicated pilot bits, but rather that that was an obvious alternative. I agree with counsel for the Defendants on this point.

188. *Primary evidence.* Although the evidence of the experts and the submissions of counsel ranged more widely, the core of each side's case is straightforward and can be shortly summarised.

189. The Defendants' case is that Nortel October discloses a fractional dedicated channel, the F-DPCH, with the object of minimising code usage by time-multiplexing multiple users on a single code. The F-DPCH proposed by Nortel October contains just TPC bits and dedicated pilot bits. Nortel October states that the number of users which can be

multiplexed depends on “the desired number of TPC and pilot bits”. It shows that a three-fold gain in code usage can be achieved with one TPC bit and two pilot bits. Nortel October states that “it is *assumed* that ... pilot bits are present to allow the F-DPCH to be power controlled and allow DL synchronisation to be maintained by each UE [emphasis added]”, but the skilled person would know from his common general knowledge that the pilot bits were not necessary for either of these functions. Accordingly, it would be obvious to omit the pilot bits in order further to minimise the code usage by the F-DPCH. This is all the more so because the skilled person would be aware from his common general knowledge that cdma2000 did not use dedicated pilot bits for power control. By contrast, the skilled person would know that he could not remove all the TPC bits if he wanted to retain uplink closed-loop power control.

190. Nortel May explains that the F-DPCH has been designed to permit maximum backwards compatibility with existing UMTS features, but Nortel October says that the interactions with transmit diversity and beamforming are for further study. The skilled person would know from his common general knowledge that dedicated pilot bits were only necessary for closed-loop transmit diversity with antenna verification and user-specific beamforming. Both closed-loop transmit diversity with antenna verification and user-specific beamforming were more beneficial for higher power channels, but the F-DPCH was to be a low power channel. Moreover, there were alternatives available to both techniques: fixed-grid beamforming and open-loop transmit diversity.
191. Accordingly, the Defendants say, the skilled person reading Nortel October at the Priority Date would have been presented with an obvious choice: retain the dedicated pilot bits and with them the ability to perform user-specific beamforming and closed-loop transmit diversity with antenna verification, or remove the dedicated pilot bits and lose that ability in order to reduce code usage. This was a straightforward trade-off. Moreover, it is not a trade-off that the Patent avoids. The Patent simply accepts the loss of the ability to carry out user-specific beamforming and closed-loop transmit diversity with antenna verification as the price for the improvement in utilisation of the system resource.
192. Philips’ case is that Nortel October is a very carefully worked out proposal which delivered a significant (up to three-fold) improvement in code utilisation while at the same time maintaining maximum backwards compatibility. There is no suggestion in Nortel October that the dedicated pilot bits should be omitted. On the contrary, the skilled person would understand that the dedicated pilot bits had been deliberately retained in order to ensure maximum backwards compatibility. Moreover, the skilled person would note that, compared with Nortel May, Nortel October increases the number of pilot bits relative to the number of TPC bits from a minimum ratio of 1:1 to a minimum ratio of 2:1. The skilled person would know from his common general knowledge that dedicated pilot bits were necessary for user-specific beamforming and closed-loop transmit diversity with antenna verification and were in fact used for the other purposes discussed above in devices which complied with UMTS Release 5. Thus the skilled person would be concerned at the implementation consequences for MS manufacturers of omitting the dedicated pilot bits. In those circumstances, it would go against the grain of the skilled person’s thinking to omit dedicated pilot bits.
193. In my judgment the evidence of the experts shows that omitting the dedicated pilot bits from the F-DPCH proposed in Nortel October was a technically obvious choice for the reasons given by the Defendants which I have summarised above. Mr Kahtava agreed

that the skilled person would be interested in Nortel October's proposal and would want to pursue the F-DPCH. Moreover, he agreed that a skilled person who was developing Release 5 would want to maximise the number of MSs on a code. He also agreed that the skilled person would be able to implement a modified F-DPCH with no pilot bits using his common general knowledge, and would see benefits from omitting the pilot bits. Although Mr Kahtava made a point about performance issues in relation to the one-slot delay, this is not a requirement of the claim or something the Patent addresses. As for the point about the ratio of TPC bits to pilot bits, Mr Kahtava agreed that they have different functions and thus the ratio between them in Nortel October is not of any particular significance. It was clear from Mr Kahtava's evidence that his reasons for saying that it would go against the grain of the skilled person's thinking to omit the dedicated pilot bits from the F-DPCH in Nortel October were because of the impact on backwards compatibility and implementation issues. The impact on backwards compatibility in term of the technical capabilities of the system would be limited for the reasons given by the Defendants, however. Moreover, as Mr Kahtava accepted, the skilled person would appreciate that it would be possible to have two slot structures for the F-DPCH, one with and one without pilot bits. That would enable the skilled person to retain the capability for user-specific beamforming and closed-loop transmit diversity with antenna verification if so desired. Thus the key factor in Mr Kahtava's reasoning was that of the costs of implementing the new channel without the pilot bits. When Mr Kahtava was asked to assume that the skilled person was not concerned with costs, he readily accepted that it would be obvious to remove the pilot bits.

194. Prof Purat's evidence was that, given Nortel October's objective, the skilled person would naturally consider whether the number of users on a single code could be increased further. The skilled person would see that the only options to reduce code usage were to reduce the number of TPC bits to one or to remove the pilot bits. The skilled person would know that the pilot bits were not technically necessary and would be aware that cdma2000 did not have dedicated pilot bits. Accordingly, omitting the pilot bits would be an obvious choice. Although this would involve the disadvantage that user-specific beamforming and closed-loop transmit diversity with antenna verification could not be applied to the F-DPCH, the skilled person would consider that a minor disadvantage which was outweighed by the increase in the number of users for each code. Prof Purat accepted that the skilled person would appreciate that open-loop transmit diversity could not be used with the first three slot formats ("structures") proposed in section 6.x.1.3 of Nortel October, but did not accept that this meant that it was not obvious that the dedicated pilot bits could be omitted. For the reasons explained above, I have approached Prof Purat's evidence in relation to Nortel October with caution because of the risk that his opinions may have been based on hindsight. Given that Mr Kahtava's evidence was largely consistent with that of Prof Purat, however, I have concluded that Prof Purat's opinions were not tainted by hindsight.
195. *Secondary evidence.* Both sides rely upon secondary evidence as supporting their respective cases.
196. The Defendants rely upon discussions which took place under the auspices of the Operator Harmonisation Group ("OHG") in 1999. OHG was an attempt to harmonise 3GPP and 3GPP2 which ultimately failed. Nevertheless, it led to certain changes being introduced into UMTS as part of Release 99. At that time, the common pilot channel had just been introduced. At the same time, an issue arose over support for the

cdma2000 EVRC voice codec. The issue was that, at low spreading factor, there was not enough room for it in a UMTS slot. WG1 therefore considered the appropriate slot format, and expressly considered removing the dedicated pilot bits in order to free up space. In the end, it decided not to do so since they were beneficial for SIR estimation and transmit diversity. Accordingly, dedicated pilot bits were mandated in each of Release 99, Release 4 and Release 5. It was put to Mr Kahtava that the contemporaneous documents relating to these discussions showed that it was natural to consider reducing or removing pilot bits in order to free up capacity. Mr Kahtava accepted that it was a natural thing to consider in that context. He did not agree that the same would apply with the F-DPCH, but it was clear that this was only because of his point on implementation: in 1999 there were no existing implementations of UMTS, whereas in 2003 there were. The Defendants contend that the 1999 debate supports their case that it was technically obvious to consider removing the pilot bits in order to reduce code usage. I agree with this.

197. Philips relies upon the fact that the Nortel team which worked on Nortel May, Nortel October and Nortel 3, which included Evelyne Le Strat and Sarah Boumendil, were leaders in the field and inventive individuals. Moreover, they developed the proposal over a number of months. Yet Nortel did not propose omitting the pilot bits. I am not persuaded that this shows that it was not obvious. It is very clear from Nortel May that Nortel chose, when designing the F-DPCH, to do so in a way which maximised backwards compatibility. Nortel would have good commercial reasons for doing so, namely to increase the chances of its proposal being accepted by TSG RAN. To that end, Nortel accepted a series of self-imposed constraints. Given those constraints, it is not surprising that Nortel did not propose omitting the pilot bits. That does not mean that it was not a technically obvious possibility. Philips points out that Evelyne Le Strat had been involved in the OHG discussions in 1999 considered above, but that seems to me to support the conclusion that the reasons Nortel did not propose omitting the pilot bits in 2003 were commercial rather than technical.
198. *Conclusion.* Overall, I consider that the secondary evidence reinforces the conclusion which I would reach if the primary evidence stood alone. In my judgment claim 1 of the Patent as proposed to be amended is obvious over Nortel October.
199. *The Dutch decision.* The Defendants rely on a decision dated 27 September 2017 of the District Court of The Hague holding that the Patent was obvious over Nortel October together with other prior art. The Dutch court was not considering the amended claim which is before me, however, and the evidence and arguments were somewhat different. Accordingly, I have to make my decision based on the amended claim and the evidence and arguments before me. Nevertheless, my conclusion is consistent with that of the Dutch court.

Conclusion

200. The Patent is invalid.